

# **ARYAN SCHOOL OF ENGINEERING & TECHNOLOGY**

**BARAKUDA, PANCHAGAON, BHUBANESWAR, KHORDHA-752050**



## **LECTURE NOTE**

**SUBJECT NAME- PRODUCTION TECHNOLOGY**

**BRANCH – MECHANICAL ENGINEERING**

**SEMESTER - 3<sup>RD</sup> SEM**

**ACADEMIC SESSION - 2022-23**

**PREPARED BY – BHAGYASHREE PANDA**

## METAL CASTING

### Introduction

Virtually nothing moves, turns, rolls, or flies without the benefit of cast metal products. The metal casting industry plays a key role in all the major sectors of our economy. There are castings in locomotives, cars trucks, aircraft, office buildings, factories, schools, and homes. [Figure](#) some metal cast parts.

Metal Casting is one of the oldest materials shaping methods known. Casting means pouring molten metal into a mold with a cavity of the shape to be made, and allowing it to solidify. When solidified, the desired metal object is taken out from the mold either by breaking the mold or taking the mold apart. The solidified object is called the casting. By this process, intricate parts can be given strength and rigidity frequently not obtainable by any other manufacturing process. The mold, into which the metal is poured, is made of some heat resisting material. Sand is most often used as it resists the high temperature of the molten metal. Permanent molds of metal can also be used to cast products.

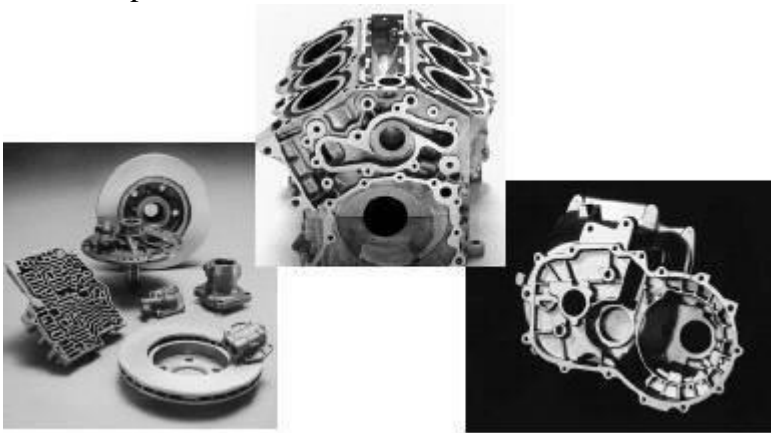

**Figure 0: Metal Cast parts**

### Advantages

The metal casting process is extensively used in manufacturing because of its many advantages.

1. Molten material can flow into very small sections so that intricate shapes can be made by this process. As a result, many other operations, such as machining, forging, and welding, can be minimized or eliminated.
2. It is possible to cast practically any material that is ferrous or non-ferrous.
3. As the metal can be placed exactly where it is required, large saving in weight can be achieved.
4. The necessary tools required for casting molds are very simple and inexpensive. As a result, for production of a small lot, it is the ideal process.
5. There are certain parts made from metals and alloys that can only be processed this way.
6. Size and weight of the product is not a limitation for the casting process.

### Limitations

1. Dimensional accuracy and surface finish of the castings made by sand casting processes are a limitation to this technique. Many new casting processes have been developed which can take into consideration the aspects of dimensional accuracy and surface finish. Some of these processes are die casting process, investment casting process, vacuum-sealed molding process, and shell molding process.
2. The metal casting process is a labor intensive process

## History

Casting technology, according to biblical records, reaches back almost 5,000 years BC. Gold, pure in nature, most likely caught Prehistoric man's fancy...as he probably hammered gold ornaments out of the gold nuggets he found. Silver would have been treated similarly. Mankind next found copper, because it appeared in the ash of his camp fires from copper-bearing ore that he lined his fire pits with. Man soon found that copper was harder than gold or silver. Copper did not bend up when used. So copper, found a 'nitch' in man's early tools, and then marched it's way into Weaponry. But, long before all this...man found clay. So he made pottery – something to eat from. Then he thought, "now...what else can I do with this mud..." . Early man thought about it, "they used this pottery stuff, ( the first patterns ), to shape metal into bowls " .

**3200 B.C.** A copper frog, the oldest known casting in existence, is cast in Mesopotamia.

**233 B.C.** Cast iron plowshares are poured in China.

**500 A.D.** Cast crucible steel is first produced in India, but the process is lost until 1750, when Benjamin Huntsman reinvents it in England.

**1455** Dillenburg Castle in Germany is the first to use cast iron pipe to transport water.

**1480** Birth of Vannoccio Biringuccio (1480-1539), the "father of the foundry industry," in Italy. He is the first man to document the foundry process in writing.

**1709** Englishman Abraham Darby creates the first true foundry flask for sand and loam molding.

**1750** Benjamin Huntsman reinvents the process of cast crucible steel in England. This process is the first in which the steel is completely melted, producing a uniform composition within the melt. Since the metal is completely molten, it also allows for alloy steel production, as the additional elements in the alloy can be added to the crucible during melting. Prior steel production was accomplished by a combination of forging and tempering, and the metal never reached a molten state.

**1809** Centrifugal casting is developed by A. G. Eckhardt of Soho, England.

**1896** American Foundrymen's Association (renamed American Foundrymen's Society in 1948 and now called the American Foundry Society) is formed.

**1897** Investment casting is rediscovered by B.F. Philbrook of Iowa. He uses it to cast dental inlays.

**1947** The Shell process, invented by J. Croning of Germany during WWII, is discovered by U.S. officials and made public.

**1953** The Hotbox system of making and curing cores in one operation is developed, eliminating the need for dielectric drying ovens.

**1958** H.F. Shroyer is granted a patent for the full mold process, the forerunner of the expendable pattern (lost foam) casting process.

**1968** The Coldbox process is introduced by L. Toriello and J. Robins for high production core making.

**1971** The Japanese develop V-Process molding. This method uses unbonded sand and a vacuum.

**1971** Rheocasting is developed at Massachusetts Institute of Technology.

**1996** Cast metal matrix composites are first used in a production model automobile in the brake rotors for the Lotus Elise.

## **Metal Casting History (India)**

**3000 BC** Earliest castings include the 11 cm high bronze dancing girl found at Mohen-jo-daro.

**2000 BC** Iron pillars, arrows, hooks, nails, bowls and daggers or earlier have been found in Delhi, Roopar, Nashik and other places.

**500 BC** Large scale state-owned mints and jewelry units, and processes of metal extraction and alloying have been mentioned in Kautilya's *Arthashastra*

**500 A.D.** Cast crucible steel is first produced in India, but the process is lost until 1750, when Benjamin Huntsman reinvents it in England.

1. **Flask:** A metal or wood frame, without fixed top or bottom, in which the mold is formed. Depending upon the position of the flask in the molding structure, it is referred to by various names such as drag – lower molding flask, cope – upper molding flask, cheek – intermediate molding flask used in three piece molding.
2. **Pattern:** It is the replica of the final object to be made. The mold cavity is made with the help of pattern.
3. **Parting line:** This is the dividing line between the two molding flasks that makes up the mold.
4. **Molding sand:** Sand, which binds strongly without losing its permeability to air or gases. It is a mixture of silica sand, clay, and moisture in appropriate proportions.
5. **Facing sand:** The small amount of carbonaceous material sprinkled on the inner surface of the mold cavity to give a better surface finish to the castings.
6. **Core:** A separate part of the mold, made of sand and generally baked, which is used to create openings and various shaped cavities in the castings.
7. **Pouring basin:** A small funnel shaped cavity at the top of the mold into which the molten metal is poured.
8. **Sprue:** The passage through which the molten metal, from the pouring basin, reaches the mold cavity. In many cases it controls the flow of metal into the mold.
9. **Runner:** The channel through which the molten metal is carried from the sprue to the gate.
10. **Gate:** A channel through which the molten metal enters the mold cavity.
11. **Chaplets:** Chaplets are used to support the cores inside the mold cavity to take care of its own weight and overcome the metallostatic force.
12. **Riser:** A column of molten metal placed in the mold to feed the castings as it shrinks and solidifies. Also known as “feed head”.

13. Vent: Small opening in the mold to facilitate escape of air and gases.

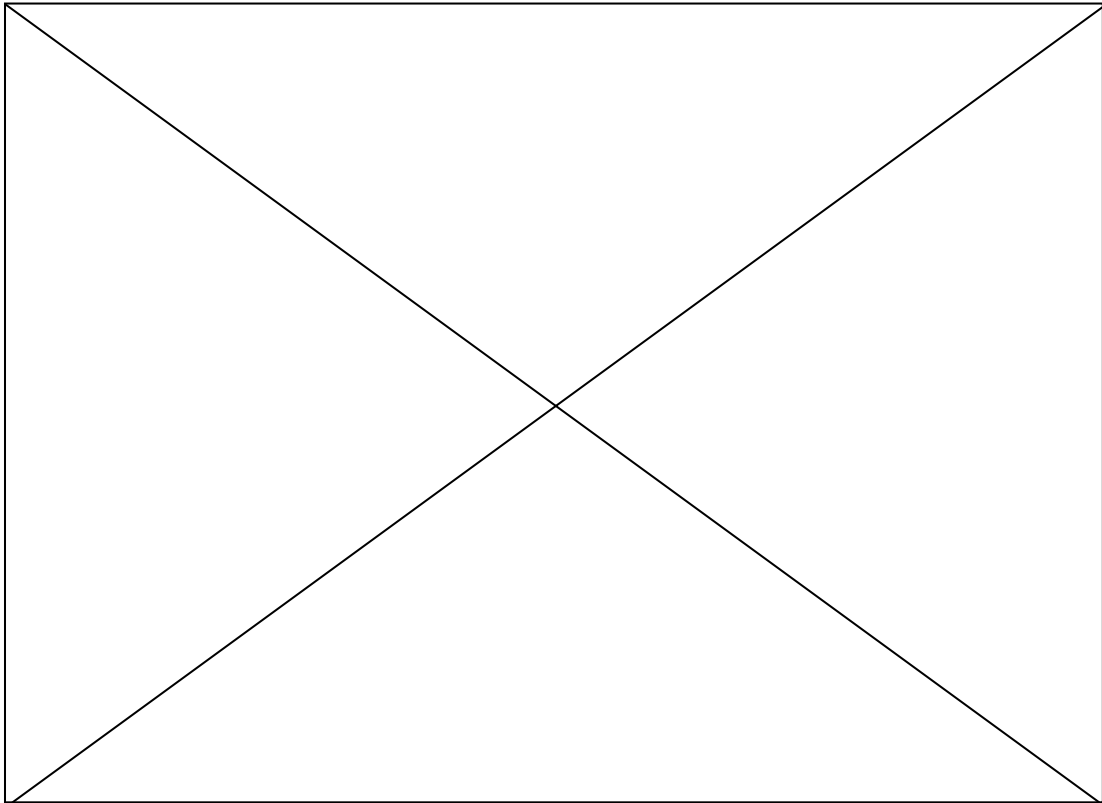

### **Steps in Making Sand Castings**

There are six basic steps in making sand castings:

1. Patternmaking
2. Core making
3. Molding
4. Melting and pouring
5. Cleaning

#### **Pattern making**

The pattern is a physical model of the casting used to make the mold. The mold is made by packing some readily formed aggregate material, such as molding sand, around the pattern. When the pattern is withdrawn, its imprint provides the mold cavity, which is ultimately filled with metal to become the casting. If the casting is to be hollow, as in the case of pipe fittings, additional patterns, referred to as cores, are used to form these cavities.

#### **Core making**

Cores are forms, usually made of sand, which are placed into a mold cavity to form the interior surfaces of castings. Thus the void space between the core and mold-cavity surface is what eventually becomes the casting.

#### **Molding**

Molding consists of all operations necessary to prepare a mold for receiving molten metal. Molding usually involves placing a molding aggregate around a pattern held with a supporting frame, withdrawing the pattern to leave the mold cavity, setting the cores in the mold cavity and finishing and closing the mold.

## **Melting and Pouring**

The preparation of molten metal for casting is referred to simply as melting. Melting is usually done in a specifically designated area of the foundry, and the molten metal is transferred to the pouring area where the molds are filled.

## **Cleaning**

Cleaning refers to all operations necessary to the removal of sand, scale, and excess metal from the casting. Burned-on sand and scale are removed to improved the surface appearance of the casting. Excess metal, in the form of fins, wires, parting line fins, and gates, is removed. Inspection of the casting for defects and general quality is performed.

1. **Flask:** A metal or wood frame, without fixed top or bottom, in which the mold is formed. Depending upon the position of the flask in the molding structure, it is referred to by various names such as drag – lower molding flask, cope – upper molding flask, cheek – intermediate molding flask used in three piece molding.
2. **Pattern:** It is the replica of the final object to be made. The mold cavity is made with the help of pattern.
3. **Parting line:** This is the dividing line between the two molding flasks that makes up the mold.
4. **Molding sand:** Sand, which binds strongly without losing its permeability to air or gases. It is a mixture of silica sand, clay, and moisture in appropriate proportions.
5. **Facing sand:** The small amount of carbonaceous material sprinkled on the inner surface of the mold cavity to give a better surface finish to the castings.
6. **Core:** A separate part of the mold, made of sand and generally baked, which is used to create openings and various shaped cavities in the castings.
7. **Pouring basin:** A small funnel shaped cavity at the top of the mold into which the molten metal is poured.
8. **Sprue:** The passage through which the molten metal, from the pouring basin, reaches the mold cavity. In many cases it controls the flow of metal into the mold.
9. **Runner:** The channel through which the molten metal is carried from the sprue to the gate.
10. **Gate:** A channel through which the molten metal enters the mold cavity.
11. **Chaplets:** Chaplets are used to support the cores inside the mold cavity to take care of its own weight and overcome the metallostatic force.
12. **Riser:** A column of molten metal placed in the mold to feed the castings as it shrinks and solidifies. Also known as “feed head”.
13. **Vent:** Small opening in the mold to facilitate escape of air and gases.

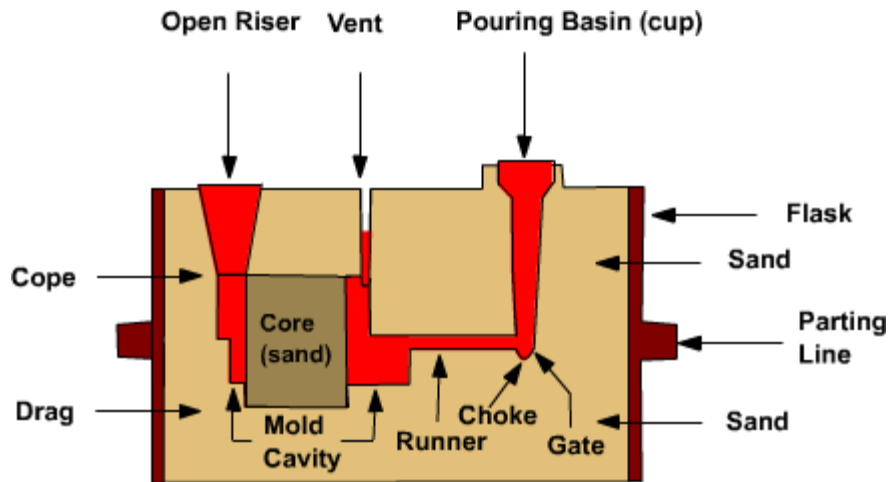

Figure 1: Mold Section showing some casting terms

### Steps in Making Sand Castings

There are six basic steps in making sand castings:

1. Patternmaking
2. Core making
3. Molding
4. Melting and pouring
5. Cleaning

### Pattern making

The pattern is a physical model of the casting used to make the mold. The mold is made by packing some readily formed aggregate material, such as molding sand, around the pattern. When the pattern is withdrawn, its imprint provides the mold cavity, which is ultimately filled with metal to become the casting. If the casting is to be hollow, as in the case of pipe fittings, additional patterns, referred to as cores, are used to form these cavities.

### Core making

Cores are forms, usually made of sand, which are placed into a mold cavity to form the interior surfaces of castings. Thus the void space between the core and mold-cavity surface is what eventually becomes the casting.

### Molding

Molding consists of all operations necessary to prepare a mold for receiving molten metal. Molding usually involves placing a molding aggregate around a pattern held with a supporting frame, withdrawing the pattern to leave the mold cavity, setting the cores in the mold cavity and finishing and closing the mold.

### Melting and Pouring

The preparation of molten metal for casting is referred to simply as melting. Melting is usually done in a specifically designated area of the foundry, and the molten metal is transferred to the pouring area where the molds are filled.

### Cleaning

Cleaning refers to all operations necessary to the removal of sand, scale, and excess metal from the casting. Burned-on sand and scale are removed to improve the surface appearance of the casting. Excess metal, in the form of fins, wires, parting line fins, and gates, is removed. Inspection of the casting for defects and general quality is performed.

## **Pattern**

The pattern is the principal tool during the casting process. It is the replica of the object to be made by the casting process, with some modifications. The main modifications are the addition of pattern allowances, and the provision of core prints. If the casting is to be hollow, additional patterns called cores are used to create these cavities in the finished product. The quality of the casting produced depends upon the material of the pattern, its design, and construction. The costs of the pattern and the related equipment are reflected in the cost of the casting. The use of an expensive pattern is justified when the quantity of castings required is substantial.

### **Functions of the Pattern**

1. A pattern prepares a mold cavity for the purpose of making a casting.
2. A pattern may contain projections known as core prints if the casting requires a core and need to be made hollow.
3. Runner, gates, and risers used for feeding molten metal in the mold cavity may form a part of the pattern.
4. Patterns properly made and having finished and smooth surfaces reduce casting defects.
5. A properly constructed pattern minimizes the overall cost of the castings.

### **Pattern Material**

Patterns may be constructed from the following materials. Each material has its own advantages, limitations, and field of application. Some materials used for making patterns are: wood, metals and alloys, plastic, plaster of Paris, plastic and rubbers, wax, and resins. To be suitable for use, the pattern material should be:

1. Easily worked, shaped and joined
2. Light in weight
3. Strong, hard and durable
4. Resistant to wear and abrasion
5. Resistant to corrosion, and to chemical reactions
6. Dimensionally stable and unaffected by variations in temperature and humidity
7. Available at low cost

The usual pattern materials are wood, metal, and plastics. The most commonly used pattern material is wood, since it is readily available and of low weight. Also, it can be easily shaped and is relatively cheap. The main disadvantage of wood is its absorption of moisture, which can cause distortion and dimensional changes. Hence, proper seasoning and upkeep of wood is almost a pre-requisite for large-scale use of wood as a pattern material.



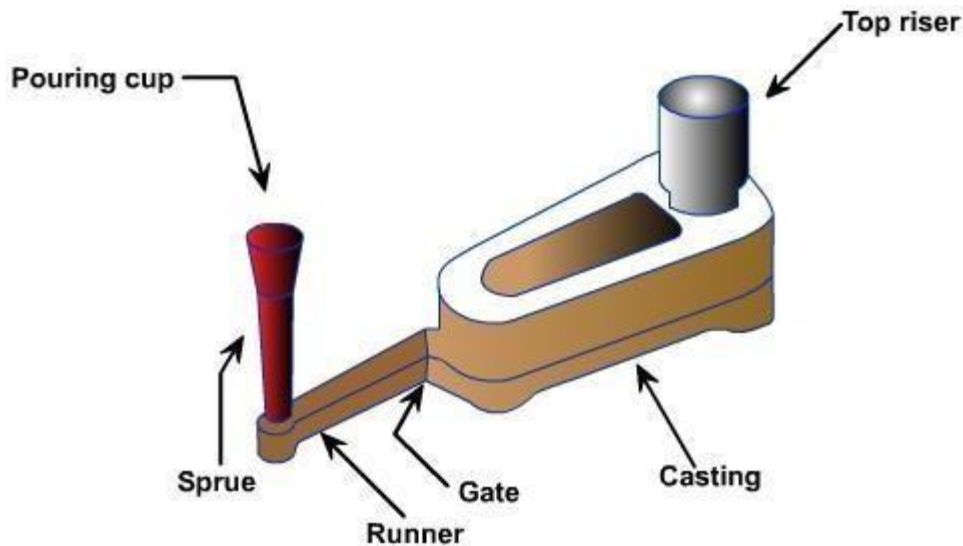

Figure 2: A typical pattern attached with gating and risering system

### Pattern Allowances

Pattern allowance is a vital feature as it affects the dimensional characteristics of the casting. Thus, when the pattern is produced, certain allowances must be given on the sizes specified in the finished component drawing so that a casting with the particular specification can be made. The selection of correct allowances greatly helps to reduce machining costs and avoid rejections. The allowances usually considered on patterns and core boxes are as follows:

1. Shrinkage or contraction allowance
2. Draft or taper allowance
3. Machining or finish allowance
4. Distortion or camber allowance
5. Rapping allowance

### Shrinkage or Contraction Allowance to view various rate of contraction of various materials)

All most all cast metals shrink or contract volumetrically on cooling. The metal shrinkage is of two types:

- i. **Liquid Shrinkage:** it refers to the reduction in volume when the metal changes from liquid state to solid state at the solidus temperature. To account for this shrinkage; riser, which feed the liquid metal to the casting, are provided in the mold.
- ii. **Solid Shrinkage:** it refers to the reduction in volume caused when metal loses temperature in solid state. To account for this, shrinkage allowance is provided on the patterns.

The rate of contraction with temperature is dependent on the material. For example steel contracts to a higher degree compared to aluminum. To compensate the solid shrinkage, a shrink rule must be used in laying out the measurements for the pattern. A shrink rule for cast iron is 1/8 inch longer per foot than a standard rule. If a gear blank of 4 inch in diameter was planned to produce out of cast iron, the shrink rule in measuring it 4 inch would actually measure 4 -1/24 inch, thus compensating for the shrinkage. The various rate of contraction of various materials are given in Table 1.

**Table 1: Rate of Contraction of Various Metals**

Material	Dimension	Shrinkage allowance (inch/ft)
Grey Cast Iron	Up to 2 feet	0.125
	2 feet to 4 feet	0.105
	over 4 feet	0.083
Cast Steel	Up to 2 feet	0.251
	2 feet to 6 feet	0.191
	over 6 feet	0.155
Aluminum	Up to 4 feet	0.155
	4 feet to 6 feet	0.143
	over 6 feet	0.125
Magnesium	Up to 4 feet	0.173
	Over 4 feet	0.155

**Exercise 1**

The casting shown is to be made in cast iron using a wooden pattern. Assuming only shrinkage allowance, calculate the dimension of the pattern. All Dimensions are in Inches

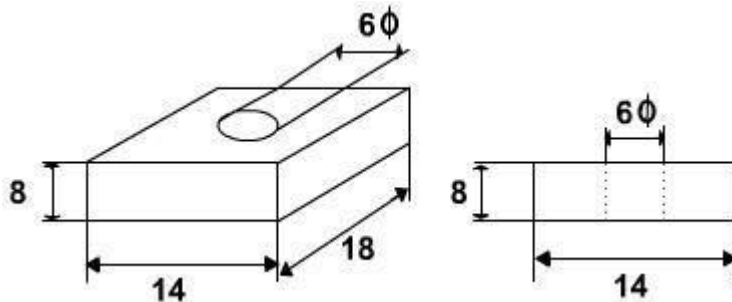

**Solution 1**

The shrinkage allowance for cast iron for size up to 2 feet is 0.125 inch per feet (as per Table 1)

For dimension 18 inch, allowance =  $18 \times 0.125 / 12 = 0.1875$  inch  $\approx 0.2$  inch

For dimension 14 inch, allowance =  $14 \times 0.125 / 12 = 0.146$  inch  $\approx 0.15$  inch

For dimension 8 inch, allowance =  $8 \times 0.125 / 12 = 0.0833$  inch  $\approx 0.09$  inch

For dimension 6 inch, allowance =  $6 \times 0.125 / 12 = 0.0625$  inch  $\approx 0.07$  inch

The pattern drawing with required dimension is shown below:

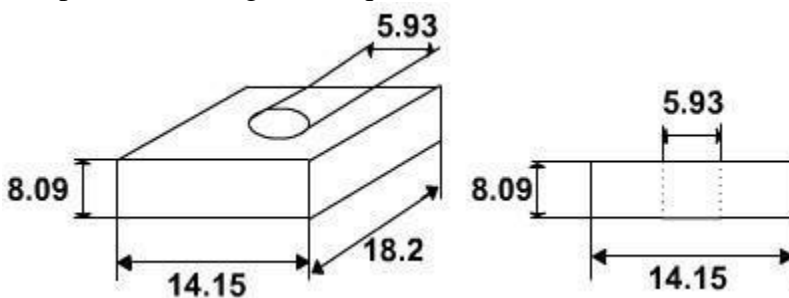

**Draft or Taper Allowance**

By draft is meant the taper provided by the pattern maker on all vertical surfaces of the pattern so that it can be removed from the sand without tearing away the sides of the sand mold and without excessive rapping by the molder. Figure 3 (a) shows a pattern having no draft allowance being

removed from the pattern. In this case, till the pattern is completely lifted out, its sides will remain in contact with the walls of the mold, thus tending to break it. Figure 3 (b) is an illustration of a pattern having proper draft allowance. Here, the moment the pattern lifting commences, all of its surfaces are well away from the sand surface. Thus the pattern can be removed without damaging the mold cavity.

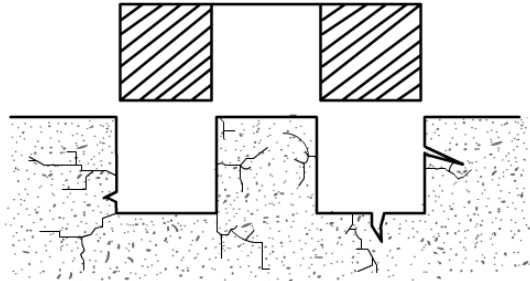

Figure 3(a): Pattern having no draft on vertical edges

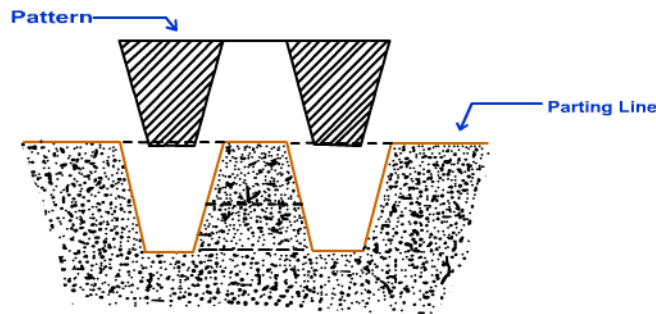

Figure 3 (b) Pattern having draft on vertical edges

Draft allowance varies with the complexity of the sand job. But in general inner details of the pattern require higher draft than outer surfaces. The amount of draft depends upon the length of the vertical side of the pattern to be extracted; the intricacy of the pattern; the method of molding; and pattern material. Table 2 provides a general guide lines for the draft allowance.

**Table 2: Draft Allowances of Various Metals**

Pattern material	Height of the given surface (inch)	Draft angle (External surface)	Draft angle (Internal surface)
Wood	1	3.00	3.00
	1 to 2	1.50	2.50
	2 to 4	1.00	1.50
	4 to 8	0.75	1.00
	8 to 32	0.50	1.00
Metal and plastic	1	1.50	3.00
	1 to 2	1.00	2.00
	2 to 4	0.75	1.00
	4 to 8	0.50	1.00
	8 to 32	0.50	0.75

### **Machining or Finish Allowance**

The finish and accuracy achieved in sand casting are generally poor and therefore when the casting is functionally required to be of good surface finish or dimensionally accurate, it is generally achieved by subsequent machining. Machining or finish allowances are therefore added in the

pattern dimension. The amount of machining allowance to be provided for is affected by the

method of molding and casting used viz. hand molding or machine molding, sand casting or metal mold casting. The amount of machining allowance is also affected by the size and shape of the casting; the casting orientation; the metal; and the degree of accuracy and finish required. The machining allowances recommended for different metal is given in Table 3.

**Table 3 : Machining Allowances of Various Metals**

Metal	Dimension (inch)	Allowance (inch)
Cast iron	Up to 12	0.12
	12 to 20	0.20
	20 to 40	0.25
Cast steel	Up to 6	0.12
	6 to 20	0.25
	20 to 40	0.30
Non ferrous	Up to 8	0.09
	8 to 12	0.12
	12 to 40	0.16

### **Distortion or Camber Allowance**

Sometimes castings get distorted, during solidification, due to their typical shape. For example, if the casting has the form of the letter U, V, T, or L etc. it will tend to contract at the closed end causing the vertical legs to look slightly inclined. This can be prevented by making the legs of the U, V, T, or L shaped pattern converge slightly (inward) so that the casting after distortion will have its sides vertical ( [Figure 4](#)).

The distortion in casting may occur due to internal stresses. These internal stresses are caused on account of unequal cooling of different section of the casting and hindered contraction. Measure taken to prevent the distortion in casting include:

- i. Modification of casting design
- ii. Providing sufficient machining allowance to cover the distortion affect
- iii. Providing suitable allowance on the pattern, called camber or distortion allowance (inverse reflection)

### **Rapping Allowance**

Before the withdrawal from the sand mold, the pattern is rapped all around the vertical faces to enlarge the mold cavity slightly, which facilitate its removal. Since it enlarges the final casting made, it is desirable that the original pattern dimension should be reduced to account for this increase. There is no sure way of quantifying this allowance, since it is highly dependent on the foundry personnel practice involved. It is a negative allowance and is to be applied only to those dimensions that are parallel to the parting plane.

### **Core and Core Prints**

Castings are often required to have holes, recesses, etc. of various sizes and shapes. These impressions can be obtained by using cores. So where coring is required, provision should be made to support the core inside the mold cavity. Core prints are used to serve this purpose. The core print is an added projection on the pattern and it forms a seat in the mold on which the sand core rests during pouring of the mold. The core print must be of adequate size and shape so that it can support the weight of the core during the casting operation. Depending upon the requirement a core can be placed horizontal, vertical and can be hanged inside the mold cavity. A typical job, its pattern and the mold cavity with core and core print is shown in Figure 5.

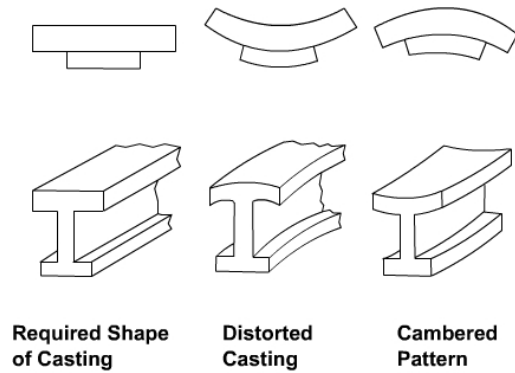

Figure 4: Distortions in castings

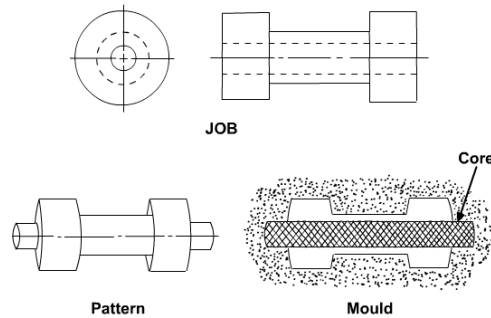

Figure 5: A typical Job, its pattern and the mold cavity

## Gating System

Gating system refers to all those elements which are connected with the flow of molten metal from the ladle to the mould cavity. The various elements that are connected with the gating system are:

- Pouring Basin
- Sprue
- Sprue-base well
- Runner
- Runner Extension
- In-gate
- Riser

**Pouring Basin:** In order to avoid mould erosion, molten metal is poured into a pouring basin, which acts as a reservoir from which it moves smoothly into the sprue. The pouring basin is also able to stop the slag from entering the mould cavity by means of a skimmer or skim core.

**Sprue:** It is the channel through which the molten metal is brought into the parting plane, where it enters the runners and gates to ultimately reach the mould cavity. If the sprue were to be straight-cylindrical then the metal flow would not be full at the bottom to avoid this problem the sprue is designed taper.

**Sprue Base Well:** This is a reservoir for metal at the bottom of the sprue, to reduce the momentum of the molten metal.

- **Runner :** The runner takes the molten metal from sprue to the casting. Ingate: This is the final stage where the molten metal moves from the runner to the mold cavity.
- **Riser**  
Riser is a source of extra metal which flows from riser to mold cavity to compensate for shrinkage which takes place in the casting when it starts solidifying. Without a riser heavier parts of the casting will have shrinkage defects, either on the surface or internally.

### **Types of Gating Systems :**

The gating system also depends on the direction of the parting plane, which contains the sprue, runner and the ingate. They are as follows:

**Horizontal Gating System :** This is used most widely. This type is normally applied in ferrous metal's sand casting and gravity die-casting of non-ferrous metals. They are used for flat casting, which are filled under gravity.

**Vertical Gating System :** This is applied in tall castings where high-pressure sand mold, shell mold and die-casting processes are done. Top Gating System : this is applied in places where the hot metal is poured from the top of the casting. It helps directional solidification of the casting from top to bottom. It suits only flat castings to limit the damage of the metal during the initial filling.

**Bottom Gating System :** it is used in tall castings where the molten metal enters the casting through the bottom.

**Middle Gating System :** It has the characteristics of both the top and bottom.

In order to provide defect-free casting the gating system should make certain provisions while designing the gating system.

1. The mould should be completely filled in the smallest time possible without having to raise the metal temperature or use high metal heads.
2. The metal should flow smoothly into the mould without any turbulence. A turbulence metal flow tends to form dross in the mould.
3. Unwanted material such as slag, dross and other mould material should not be allowed to enter the mould cavity
4. The metal entry into the mould cavity should be properly controlled in such a way that aspiration of the atmospheric air is prevented.
5. A proper thermal gradient be maintained so that the casting is cooled without any shrinkage cavities or distortions.
6. Metal flow should be maintained in such a way that no gating or mould erosion takes place.
7. The gating system should ensure that enough molten metal reaches the mould cavity
8. The gating system design should be economical and easy to implement and remove after casting solidification.
9. Ultimately, the casting yield should be maximized.

## Solidification of Metals

After pouring molten metal into a mold, a series of events takes place during the solidification of the metal and cooling to room temperature.

These events greatly influence the size, shape uniformity, and chemical composition of the grains formed throughout the casting, which in turn influence its over all properties.

**Solidification of Pure Metals:** A pure metal solidifies at a constant temperature. It has a clearly defined melting (or freezing) point (see table 3.1 and fig. 10.1). <sup>TM</sup>After the temperature of the molten metal drops to its freezing point, its temperature remains constant while the latent heat of fusion is given off. The solidification front (solid-liquid interface) moves through the molten metal, solidifying from the mold walls in toward the center.

**TABLE 3.1**  
**Physical Properties of Various Materials at Room Temperature**

Material	Density (kg/m <sup>3</sup> )	Melting point (°C)	Specific heat (J/kg K)	Thermal conductivity (W/m K)	Coefficient of thermal expansion (μm/m °C)
<b>Metallic</b>					
Aluminum	2700	660	900	222	23.6
Aluminum alloys	2630–2820	476–654	880–920	121–239	23.0–23.6
Beryllium	1854	1278	1884	146	8.5
Columbium (niobium)	8580	2468	272	52	7.1
Copper	8970	1082	385	393	16.5
Copper alloys	7470–8940	885–1260	337–435	29–234	16.5–20
Gold	19300	1063	129	317	19.3
Iron	7860	1537	460	74	11.5
Steels	6920–9130	1371–1532	448–502	15–52	11.7–17.3
Lead	11350	327	130	35	29.4
Lead alloys	8850–11350	182–326	126–188	24–46	27.1–31.1
Magnesium	1745	650	1025	154	26.0
Magnesium alloys	1770–1780	610–621	1046	75–138	26.0
Molybdenum alloys	10210	2610	276	142	5.1
Nickel	8910	1453	440	92	13.3
Nickel alloys	7750–8850	1110–1454	381–544	12–63	12.7–18.4
Silicon	2330	1423	712	148	7.63
Silver	10500	961	235	429	19.3
Tantalum alloys	16600	2996	142	54	6.5
Titanium	4510	1668	519	17	8.35
Titanium alloys	4430–4700	1549–1649	502–544	8–12	8.1–9.5
Tungsten	19290	3410	138	166	4.5
<b>Nonmetallic</b>					
Ceramics	2300–5500	—	750–950	10–17	5.5–13.5
Glasses	2400–2700	580–1540	500–850	0.6–1.7	4.6–70
Graphite	1900–2200	—	840	5–10	7.86
Plastics	900–2000	110–330	1000–2000	0.1–0.4	72–200
Wood	400–700	—	2400–2800	0.1–0.4	2–60



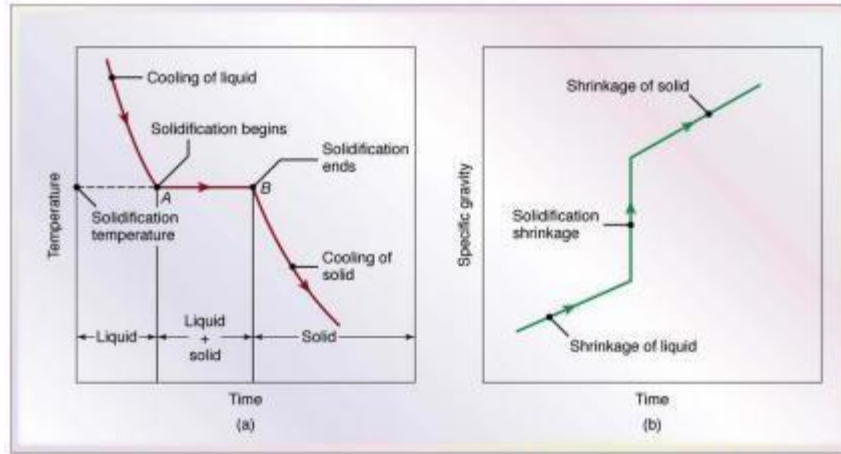

Figure 10.1 (a) Temperature as a function of time for the solidification of pure metals. Note that the freezing takes place at a constant temperature. (b) Density as a function of time.

The grain structure of a pure metal cast in a square mold is shown in Fig 10.2a: At the mold walls (usually at room temp), the metal cools rapidly and produces a solidified skin (or shell) of fine equiaxed grains (approx. equal dims. in all dirs.) The grains grow in a direction opposite to that of the heat transfer out through the mold. Those grains that have favorable orientations grow preferentially away from the surface of the mold producing columnar grains (Fig. 10.3). As the driving force of the heat transfer is reduced away from the mold walls, the grains become equiaxed and coarse. Those grains that have substantially different orientations are blocked from further growth. Such grain development is known as homogeneous nucleation, meaning that the grains grow upon themselves, starting at the mold wall.

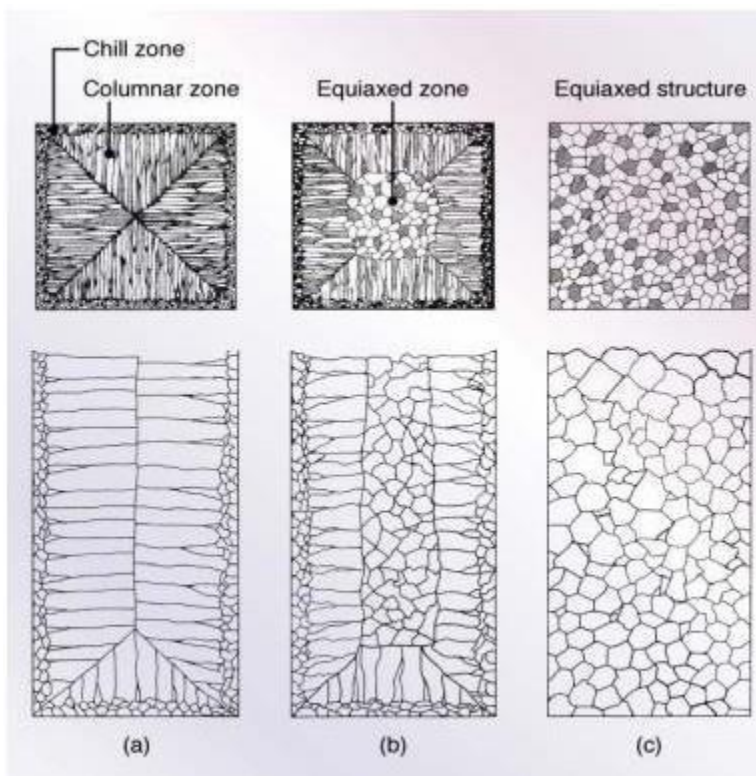

Figure 10.2 Schematic illustration of three cast structures of metals solidified in a square mold: (a) pure metals; (b) solid-solution alloys; and (c) structure obtained by using nucleating agents.

When the heat is abstracted rapidly, however, solidification it leads to fine structures due to a decrease in diffusion rates.

### Solidification of Alloys

Solidification begins when the temperature drops below the liquidus,  $T_L$ , and is complete when it reaches the solidus,  $T_S$  (Fig.10.4).

Within this temperature range, the alloy is in a mushy or pasty state with columnar dendrites (close to tree). Note the liquid metal present between the dendrite arms.

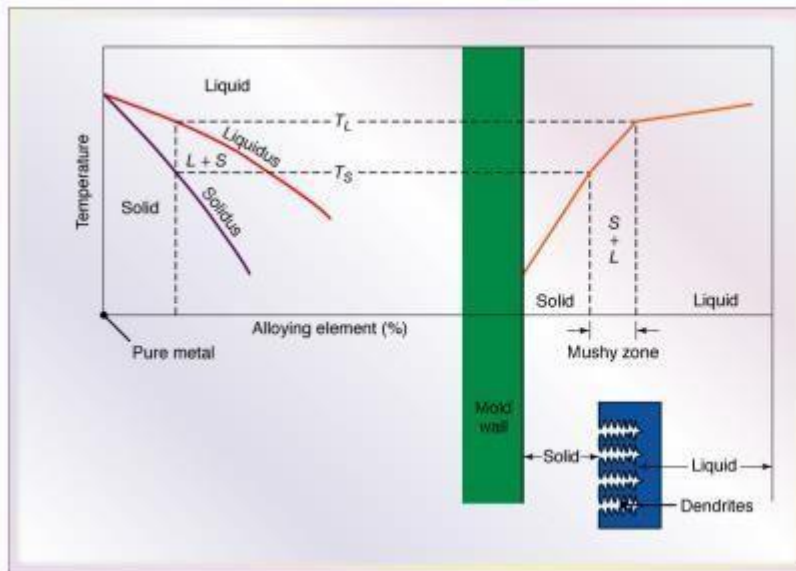
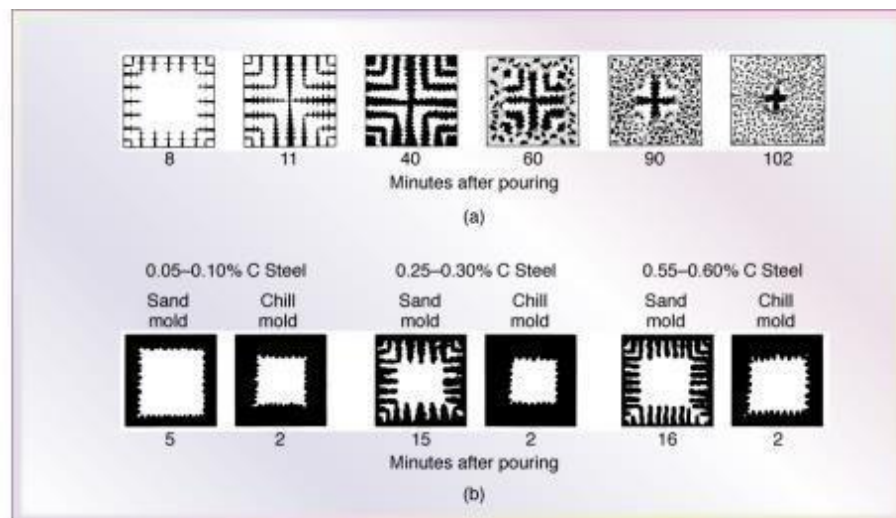

Figure 10.4 Schematic illustration of alloy solidification and temperature distribution in the solidifying metal. Note the formation of *dendrites* in the mushy zone.

Dendrites have 3-D arms and branches (secondary arms) which eventually interlock, as can be seen in Fig. 10.5.

seen in Fig. 10.5.

Figure 10.5 (a) Solidification patterns for *gray cast* iron in a 180-mm square casting. Note that after 11 minutes of cooling, dendrites reach each other, but the casting is still mushy throughout. It takes about two hours for this casting to solidify completely. (b) Solidification of *carbon steels* in sand and chill (metal) molds. Note the difference in solidification patterns as the carbon content increases.



The width of the mushy zone (L & S) is an important factor during solidification. It is described by the freezing range as:

$$\text{Freezing range} = T_L - T_S \quad (10.1)$$

It can be seen in Figure 10.1 that pure metals have no freezing range, and that the solidification front moves as a plane front without forming a mushy zone.

In alloys with a nearly symmetrical phase diagram, the structure is generally lamellar, with two or more solid phases present, depending on the alloy system.

When the volume fraction of the minor phase of the alloy is less than about 25%, the structure generally becomes fibrous. These conditions are particularly important for cast irons.

For alloys, a short freezing range generally involves a temperature difference  $< 50^\circ\text{C}$ , and a long freezing range  $> 110^\circ\text{C}$ .

Ferrous castings generally have narrow mushy zones, whereas aluminum and magnesium alloys have wide mushy zones.

## **Riser**

Riser is a source of extra metal which flows from riser to mold cavity to compensate for shrinkage which takes place in the casting when it starts solidifying. Without a riser heavier parts of the casting will have shrinkage defects, either on the surface or internally.

Risers are known by different names as metal reservoir, feeders, or headers.

Shrinkage in a mold, from the time of pouring to final casting, occurs in three stages.

1. during the liquid state
2. during the transformation from liquid to solid
3. during the solid state

First type of shrinkage is being compensated by the feeders or the gating system. For the second type of shrinkage risers are required. Risers are normally placed at that portion of the casting which is last to freeze. A riser must stay in liquid state at least as long as the casting and must be able to feed the casting during this time.

## **Functions of Risers**

- Provide extra metal to compensate for the volumetric shrinkage
- Allow mold gases to escape
- Provide extra metal pressure on the solidifying mold to reproduce mold details more exact

## **Design Requirements of Risers**

1. Riser size: For a sound casting riser must be last to freeze. The ratio of (volume / surface area)<sup>2</sup> of the riser must be greater than that of the casting. However, when this condition does not meet the metal in the riser can be kept in liquid state by heating it externally or using exothermic materials in the risers.
2. Riser placement: the spacing of risers in the casting must be considered by effectively calculating the feeding distance of the risers.
3. Riser shape: cylindrical risers are recommended for most of the castings as spherical risers, although considers as best, are difficult to cast. To increase volume/surface area ratio the bottom of the riser can be shaped as hemisphere.

### Riser Design

The riser is a reservoir in the mold that serves as a source of liquid metal for the casting to compensate for shrinkage during solidification. The riser must be designed to freeze after the main casting in order to satisfy its function. As described earlier, a riser is used in a sand-casting mold to feed liquid metal to the casting during freezing in order to compensate for solidification shrinkage. To function, the riser must remain molten until after the casting solidifies. Chvorinov's rule can be used to compute the size of a riser that will satisfy this requirement. The following example illustrates the calculation. The riser represents waste metal that will be separated from the cast part and re-melted to make subsequent castings. It is desirable for the volume of metal in the riser to be a minimum. Since the geometry of the riser is normally selected to maximize the V/A ratio, this tends to reduce the riser volume as much as possible. Risers can be designed in different forms. The design shown in Figure below is a side riser. It is attached to the side of the casting by means of a small channel. A top riser is one that is connected to the top surface of the casting. Risers can be open or blind. An open riser is exposed to the outside at the top surface of the cope. This has the disadvantage of allowing more heat to escape, promoting faster solidification. A blind riser is entirely enclosed within the mold, as in Figure below.

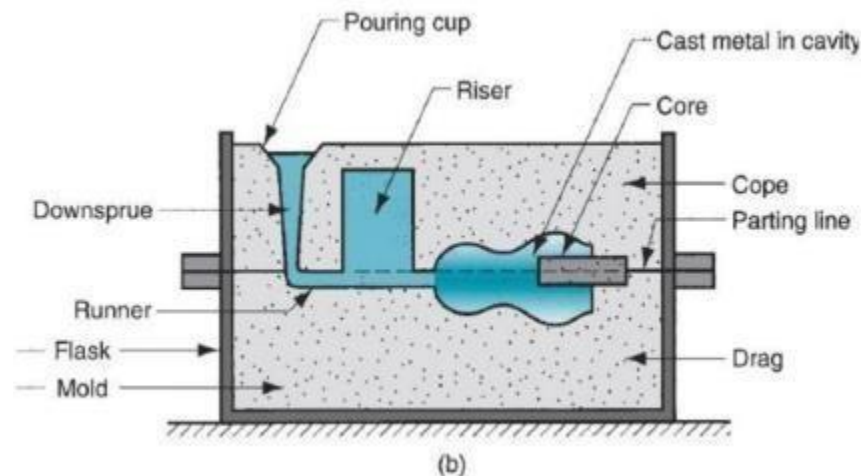

Special Casting processes:

This process was patent in 20 century to make higher standards hollow castings. The first centrifugal casting machine was invented by a British, A.G. Eckhardt in 1807. This process is widely used for casting hollow pipes, tubes and other symmetrical parts.

### Centrifugal Casting:

#### Working Principle:

It works on basic principle of centrifugal force on a rotating Component. In this process, a mould is rotated about its central axis when the molten metal is poured into it. A centrifugal force acts on molten metal due to this rotation, which forces the metal at outer wall of mould. The mould rotates until the whole casting solidifies. The slag oxide and other inclusion being lighter, gets separated from metal and segregate towards the center.

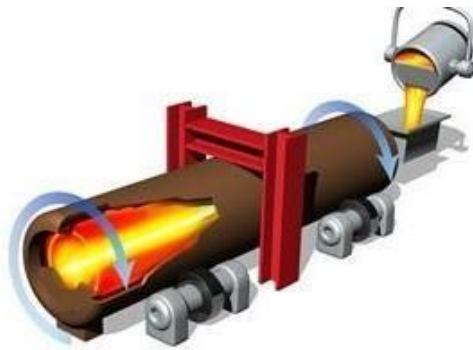

#### Types

##### True Centrifugal Casting:

True centrifugal casting is sometime known as centrifugal casting is a process of making symmetrical round hollow sections. This process uses no **cores** and the symmetrical hollow section is created by pure centrifugal action. In this process, the mould rotates about horizontal or vertical axis. Mostly the mould is rotated about horizontal axis and the molten metal introduce from an external source. The centrifugal force acts on the molten metal which forces it at the outer wall of mould. The mould rotates until the whole casting solidifies. The slag particles are lighter than metal thus separated at the central part of the casting and removed by machining or other suitable process. This process used to make hollow pipes, tubes, hollow bushes etc. which are axi symmetrical with a concentric hole.

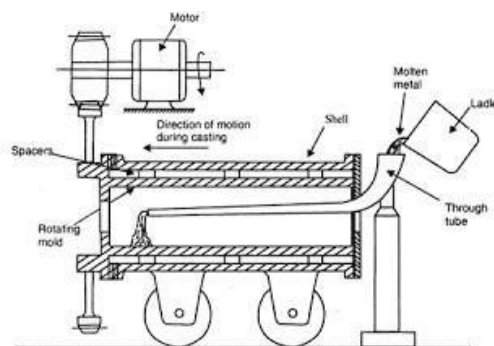

Fig. 4.15. A true centrifugal casting machine.



### Semi Centrifugal Casting:

This process is used to cast large size axi symmetrical object. In this process mould is placed horizontally and rotated along the vertical axis. A core is inserted at the center which is used to cast hollow section. When the mould rotates, the outer portion of the mould fill by purely centrifugal action and as the liquid metal approaches toward the center, the centrifugal component decreases and gravity component increase. Thus a core is inserted at center to make hollow cavity at the center without centrifugal force. In this process centrifugal force is used for uniform filling of axi symmetrical parts. Gear blanks, flywheel etc. are made by this process.

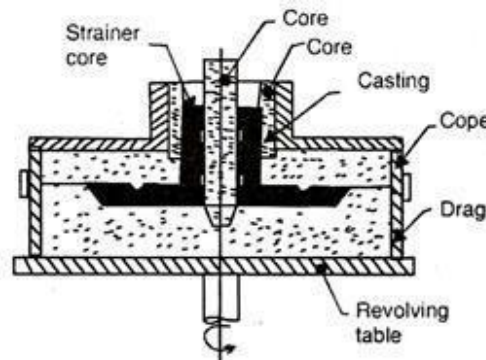

Fig. 4.16. Semi-centrifugal Casting.

### Centrifuging:

In this process there are several mould cavities connected with a central sprue with radial gates. This process uses higher metal pressure during solidification. It is used to cast shapes which are not axi symmetrical. This is only suitable for small objects.

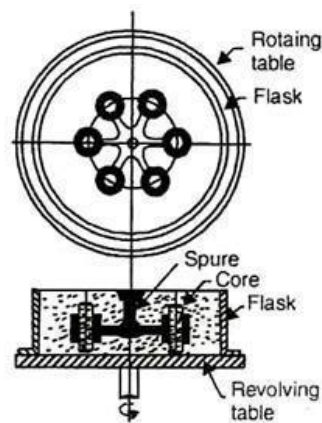

Fig. 4.17. Centrifuging casting.

### Application:

- It is widely used in aircraft industries to cast rings, flanges and compressor casting.
- It is used for cast Steam turbine bearing shell.
- Roller for steel rolling mill is another example of centrifugal casting.
- It is used in automobile industries to cast gear blank, cylindrical liners, piston rings etc.
- It is used to cast bearings.
- This process used to cast switch gear components used in electronic industries.

## Advantages and Disadvantages

Advantages:

- It provides dense metal and high mechanical properties.
- Unidirectional solidification can obtain up to a certain thickness.
- It can use for mass production.
- No cores are required for cast hollow shapes like tubes etc.
- Gating system and runner are totally eliminated.
- All the impurity like oxide or other slag particles, segregated at center from where it can easily remove.
- It required lower pouring temperature thus save energy.
- Lower casting defects due to uniform solidification.

Disadvantages:

- Limited design can be cast. It can cast only symmetrical shapes.
- High equipment or setup cost.
- It is not suitable for every metal.
- Higher maintenance required.
- High skill operator required.
- In this casting process, solidification time and temperature distribution is difficult to determine.

## Investment Casting Process

The root of the investment casting process, the cire perdue or “lost wax” method dates back to at least the fourth millennium B.C. The artists and sculptors of ancient Egypt and Mesopotamia used the rudiments of the investment casting process to create intricately detailed jewelry, pectorals and idols. The investment casting process also called lost wax process begins with the production of wax replicas or patterns of the desired shape of the castings. A pattern is needed for every casting to be produced. The patterns are prepared by injecting wax or polystyrene in a metal dies. A number of patterns are attached to a central wax sprue to form an assembly. The mold is prepared by surrounding the pattern with refractory slurry that can set at room temperature. The mold is then heated so that pattern melts and flows out, leaving a clean cavity behind. The mould is further hardened by heating and the molten metal is poured while it is still hot. When the casting is solidified, the mold is broken and the casting taken out.

The basic steps of the investment casting process are ( [Figure 11](#) ) :

1. Production of heat-disposable wax, plastic, or polystyrene patterns
2. Assembly of these patterns onto a gating system
3. “Investing,” or covering the pattern assembly with refractory slurry
4. Melting the pattern assembly to remove the pattern material
5. Firing the mold to remove the last traces of the pattern material
6. Pouring
7. Knockout, cutoff and finishing.



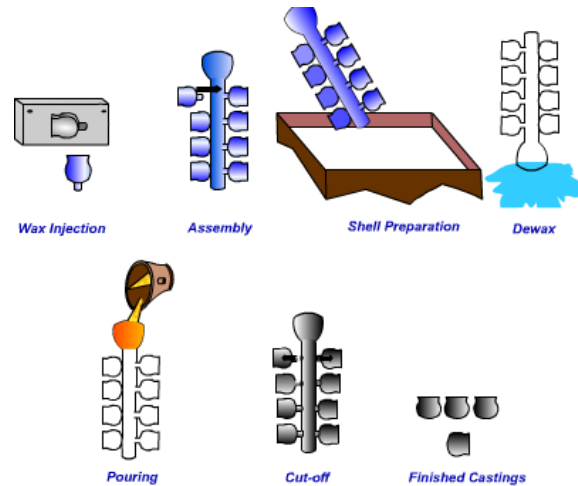

The basic Steps of Investment Casting

### Advantages

- Formation of hollow interiors in cylinders without cores
- Less material required for gate
- Fine grained structure at the outer surface of the casting free of gas and shrinkage cavities and porosity

### Disadvantages

- More segregation of alloy component during pouring under the forces of rotation
- Contamination of internal surface of castings with non-metallic inclusions
- Inaccurate internal diameter

### Ceramic Shell Investment Casting Process

The basic difference in investment casting is that in the investment casting the wax pattern is immersed in a refractory aggregate before dewaxing whereas, in ceramic shell investment casting a ceramic shell is built around a tree assembly by repeatedly dipping a pattern into a slurry (refractory material such as zircon with binder). After each dipping and stuccoing is completed, the assembly is allowed to thoroughly dry before the next coating is applied. Thus, a shell is built up around the assembly. The thickness of this shell is dependent on the size of the castings and temperature of the metal to be poured.

After the ceramic shell is completed, the entire assembly is placed into an autoclave or flash fire furnace at a high temperature. The shell is heated to about 982 o C to burn out any residual wax and to develop a high-temperature bond in the shell. The shell molds can then be stored for future use or molten metal can be poured into them immediately. If the shell molds are stored, they have to be preheated before molten metal is poured into them.

### Advantages

- excellent surface finish

- tight dimensional tolerances

- machining can be reduced or completely eliminated

## The Process

**The Mold:** Like in all permanent mold manufacturing processes, the first step in die casting is the production of the mold. The mold must be accurately created as two halves that can be opened and closed for removal of the metal casting, similar to the [basic permanent mold casting](#) process. The mold for die casting is commonly machined from steel and contains all the components of the gating system. *Multi-cavity die* are employed in manufacturing industry to produce several castings with each cycle. *Unit dies* which are a combination of smaller dies are also used to manufacture metal castings in industry.

In a die casting production setup, the mold, (or die), is designed so that its mass is far greater than that of the casting. Typically the mold will have 1000 times the mass of the metal casting. So a 2 pound part will require a mold weighing a ton! Due to the extreme pressures and the continuous exposure to thermal gradients from the molten metal, wearing of the die can be a problem. However in a well maintained manufacturing process, a die can last hundreds of thousands of cycles before needing to be replaced.

## Die Casting Machines

In addition to the opening and closing of the mold to prepare for and remove castings, it is very important that there is enough force that can be applied to hold the two halves of the mold together during the injection of the molten metal. Flow of molten metal under such pressures will create a tremendous force acting to separate the die halves during the process. Die casting machines are large and strong, designed to hold the mold together against such forces.

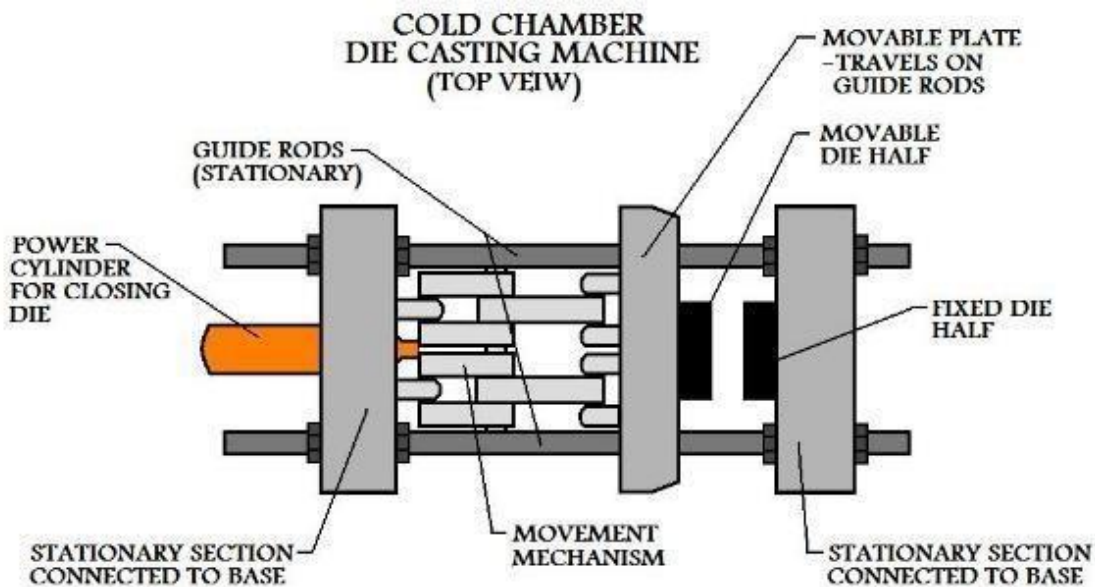

In manufacturing industry, die casting machines are rated on the force with which they can hold the mold closed. Clamping forces for these machines vary from around 25 to 3000 tons.

## Melting Practices

Melting is an equally important parameter for obtaining a quality castings. A number of furnaces can be used for melting the metal, to be used, to make a metal casting. The choice of furnace depends on the type of metal to be melted. Some of the furnaces used in metal casting are as following:.

- Crucible furnaces
- Cupola
- Induction furnace
- Reverberatory furnace

### Crucible Furnace.

Crucible furnaces are small capacity typically used for small melting applications. Crucible furnace is suitable for the batch type foundries where the metal requirement is intermittent. The metal is placed in a crucible which is made of clay and graphite. The energy is applied indirectly to the metal by heating the crucible by coke, oil or gas. The heating of crucible is done by coke, oil or gas. .

### Coke-Fired Furnace ([Figure 13](#)) .

- Primarily used for non-ferrous metals
- Furnace is of a cylindrical shape
- Also known as pit furnace
- Preparation involves: first to make a deep bed of coke in the furnace
- Burn the coke till it attains the state of maximum combustion
- Insert the crucible in the coke bed
- Remove the crucible when the melt reaches to desired temperature

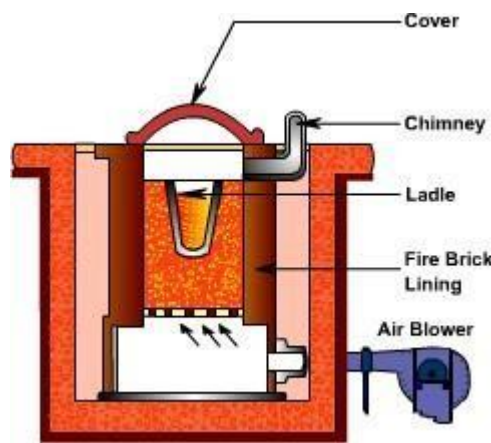

Coke Fired Crucible Furnace

## Oil-Fired Furnace.

- Primarily used for non-ferrous metals
- Furnace is of a cylindrical shape
- Advantages include: no wastage of fuel
- Less contamination of the metal
- Absorption of water vapor is least as the metal melts inside the closed metallic furnace

## Cupola

Cupola furnaces are tall, cylindrical furnaces used to melt iron and ferrous alloys in foundry operations. Alternating layers of metal and ferrous alloys, coke, and limestone are fed into the furnace from the top. A schematic diagram of a cupola is shown in [Figure 14](#). This diagram of a cupola illustrates the furnace's cylindrical shaft lined with refractory and the alternating layers of coke and metal scrap. The molten metal flows out of a spout at the bottom of the cupola. .

## Description of Cupola

- The cupola consists of a vertical cylindrical steel sheet and lined inside with acid refractory bricks. The lining is generally thicker in the lower portion of the cupola as the temperature are higher than in upper portion
- There is a charging door through which coke, pig iron, steel scrap and flux is charged
- The blast is blown through the tuyeres
- These tuyeres are arranged in one or more row around the periphery of cupola
- Hot gases which ascends from the bottom (combustion zone) preheats the iron in the preheating zone
- Cupolas are provided with a drop bottom door through which debris, consisting of coke, slag etc. can be discharged at the end of the melt
- A slag hole is provided to remove the slag from the melt
- Through the tap hole molten metal is poured into the ladle
- At the top conical cap called the spark arrester is provided to prevent the spark emerging to outside

## Operation of Cupola

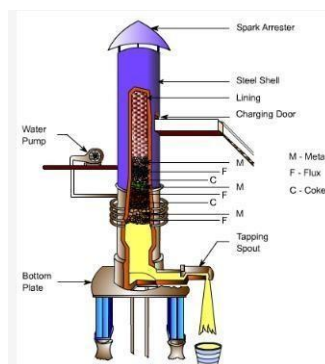

Schematic of a Cupola Furnace

## **Casting Defects:**

The following are the major defects, which are likely to occur in sand castings

- Gas defects
- Shrinkage cavities
- Molding material defects
- Pouring metal defects
- Mold shift

### **Gas Defects**

A condition existing in a casting caused by the trapping of gas in the molten metal or by mold gases evolved during the pouring of the casting. The defects in this category can be classified into blowholes and pinhole porosity. Blowholes are spherical or elongated cavities present in the casting on the surface or inside the casting. Pinhole porosity occurs due to the dissolution of hydrogen gas, which gets entrapped during heating of molten metal.

#### **Causes**

The lower gas-passing tendency of the mold, which may be due to lower venting, lower permeability of the mold or improper design of the casting. The lower permeability is caused by finer grain size of the sand, high percentage of clay in mold mixture, and excessive moisture present in the mold.

- Metal contains gas
- Mold is too hot
- Poor mold burnout

### **Shrinkage Cavities**

These are caused by liquid shrinkage occurring during the solidification of the casting. To compensate for this, proper feeding of liquid metal is required. For this reason risers are placed at the appropriate places in the mold. Sprues may be too thin, too long or not attached in the proper location, causing shrinkage cavities. It is recommended to use thick sprues to avoid shrinkage cavities.

### **Molding Material Defects**

The defects in this category are cuts and washes, metal penetration, fusion, and swell.

#### **Cut and washes**

These appear as rough spots and areas of excess metal, and are caused by erosion of molding sand by the flowing metal. This is caused by the molding sand not having enough strength and the molten metal flowing at high velocity. The former can be taken care of by the proper choice of molding sand and the latter can be overcome by the proper design of the gating system.

## **Metal penetration**

When molten metal enters into the gaps between sand grains, the result is a rough casting surface. This occurs because the sand is coarse or no mold wash was applied on the surface of the mold. The coarser the sand grains more the metal penetration.

## **Fusion**

This is caused by the fusion of the sand grains with the molten metal, giving a brittle, glassy appearance on the casting surface. The main reason for this is that the clay or the sand particles are of lower refractoriness or that the pouring temperature is too high.

## **Swell**

Under the influence of metallostatic forces, the mold wall may move back causing a swell in the dimension of the casting. A proper ramming of the mold will correct this defect.

## **Inclusions**

Particles of slag, refractory materials, sand or deoxidation products are trapped in the casting during pouring solidification. The provision of choke in the gating system and the pouring basin at the top of the mold can prevent this defect.

## **Pouring Metal Defects**

The likely defects in this category are

- Mis-runs and
- Cold shuts.

A mis-run is caused when the metal is unable to fill the mold cavity completely and thus leaves unfilled cavities. A mis-run results when the metal is too cold to flow to the extremities of the mold cavity before freezing. Long, thin sections are subject to this defect and should be avoided in casting design.

A cold shut is caused when two streams while meeting in the mold cavity, do not fuse together properly thus forming a discontinuity in the casting. When the molten metal is poured into the mold cavity through more-than-one gate, multiple liquid fronts will have to flow together and become one solid. If the flowing metal fronts are too cool, they may not flow together, but will leave a seam in the part. Such a seam is called a cold shut, and can be prevented by assuring sufficient superheat in the poured metal and thick enough walls in the casting design.

The mis-run and cold shut defects are caused either by a lower fluidity of the mold or when the section thickness of the casting is very small. Fluidity can be improved by changing the composition of the metal and by increasing the pouring temperature of the metal.

## Mold Shift

The mold shift defect occurs when cope and drag or molding boxes have not been properly aligned.

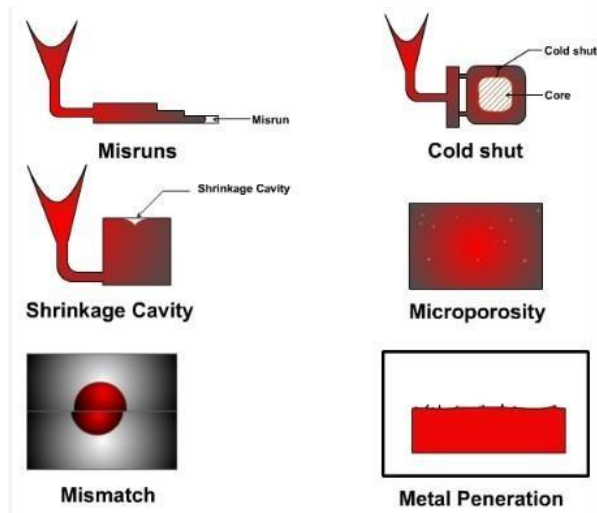

Casting Defects



## Unit - II

### Introduction:

Welding which is the process of joining two metallic components for the desired purpose, can be defined as the process of joining two similar or dissimilar metallic components with the application of heat, with or without the application of pressure and with or without the use of filler metal. Heat may be obtained by chemical reaction, electric arc, electrical resistance, frictional heat, sound and light energy. If no filler metal is used during welding then it is termed as 'Autogenous Welding Process'.

During 'Bronze Age' parts were joined by forge welding to produce tools, weapons and ornaments etc, however, present day welding processes have been developed within a period of about a century.

First application of welding with carbon electrode was developed in 1885 while metal arc welding with bare electrode was patented in 1890. However, these developments were more of experimental value and applicable only for repair welding but proved to be the important base for present day manual metal arc (MMAW) welding and other arc welding processes.

In the mean time resistance butt welding was invented in USA in the year 1886. Other resistance welding processes such as spot and flash welding with manual application of load were developed around 1905.

With the production of cheap oxygen in 1902, oxy – acetylene welding became feasible in Europe in 1903.

When the coated electrodes were developed in 1907, the manual metal arc welding process become viable for production/fabrication of components and assemblies in the industries on large scale.

Subsequently other developments are as follows:

- Thermit Welding (1903)
- Cellulosic Electrodes (1918)
- Arc Stud Welding (1918)
- Seam Welding of Tubes (1922)
- Mechanical Flash Welder for Joining Rails (1924)
- Extruded Coating for MMAW Electrodes (1926)
- Submerged Arc Welding (1935)
- Air Arc Gouging (1939)
- Inert Gas Tungsten Arc (TIG) Welding (1941)
- Iron Powder Electrodes with High Recovery (1944)
- Inert Gas Metal Arc (MIG) Welding (1948)
- Electro Slag Welding (1951)
- Flux Cored Wire with CO<sub>2</sub> Shielding (1954)
- Electron Beam Welding (1954)
- Constricted Arc (Plasma) for Cutting (1955)
- Friction Welding (1956)
- Plasma Arc Welding (1957)

- Electro Gas Welding (1957)
- Short Circuit Transfer for Low Current, Low Voltage Welding with CO<sub>2</sub> Shielding (1957)
- Vacuum Diffusion Welding (1959)
- Explosive Welding (1960)
- Laser Beam Welding (1961)
- High Power CO<sub>2</sub> Laser Beam Welding (1964)

All welded 'Liberty' ships failure in 1942, gave a big jolt to application of welding. However, it had drawn attention to fracture problem in welded structures.

### **Applications:**

Although most of the welding processes at the time of their developments could not get their place in the production except for repair welding, however, at the later stage these found proper place in manufacturing/production. Presently welding is widely being used in fabrication of pressure vessels, bridges, building structures, aircraft and space crafts, railway coaches and general applications. It is also being used in shipbuilding, automobile, electrical, electronic and defense industries, laying of pipe lines and railway tracks and nuclear installations etc.

### **General Applications:**

Welding is vastly being used for construction of transport tankers for transporting oil, water, milk and fabrication of welded tubes and pipes, chains, LPG cylinders and other items. Steel furniture, gates, doors and door frames, body and other parts of white goods items such as refrigerators, washing machines, microwave ovens and many other items of general applications are fabricated by welding.

### **Pressure Vessels:**

One of the first major use of welding was in the fabrication of pressure vessels. Welding made considerable increases in the operating temperatures and pressures possible as compared to riveted pressure vessels.

### **Bridges:**

Early use of welding in bridge construction took place in Australia. This was due to problems in transporting complete riveted spans or heavy riveting machines necessary for fabrication on site to remote areas. The first all welded bridge was erected in UK in 1934. Since then all welded bridges are erected very commonly and successfully.

### **Ship Building:**

Ships were produced earlier by riveting. Over ten million rivets were used in 'Queen Mary' ship which required skills and massive organization for riveting but welding would have allowed the semiskilled/ unskilled labor and the principle of pre-fabrication. Welding found its place in ship building around 1920 and presently all welded ships are widely used. Similarly submarines are also produced by welding.

### **Building Structures:**

Arc welding is used for construction of steel building leading to considerable savings in steel and money. In addition to building, huge structures such as steel towers etc also require welding for fabrication.

**Aircraft and Spacecraft:**

Similar to ships, aircrafts were produced by riveting in early days but with the introduction of jet engines welding is widely used for aircraft structure and for joining of skin sheet to body.

Space vehicles which have to encounter frictional heat as well as low temperatures require outer skin and other parts of special materials. These materials are welded with full success achieving safety and reliability.

**Railways:**

Railways use welding extensively for fabrication of coaches and wagons, wheel tyres laying of new railway tracks by mobile flash butt welding machines and repair of cracked/damaged tracks by thermit welding.

**Automobiles:**

Production of automobile components like chassis, body and its structure, fuel tanks and joining of door hinges require welding.

**Electrical Industry:**

Starting from generation to distribution and utilization of electrical energy, welding plays important role. Components of both hydro and steam power generation system, such as penstocks, water control gates, condensers, electrical transmission towers and distribution system equipment are fabricated by welding. Turbine blades and cooling fins are also joined by welding.

**Electronic Industry:**

Electronic industry uses welding to limited extent such as for joining leads of special transistors but other joining processes such as brazing and soldering are widely being used. Soldering is used for joining electronic components to printed circuit boards. Robotic soldering is very common for joining of parts to printed circuit boards of computers, television, communication equipment and other control equipment etc.

**Nuclear Installations:**

Spheres for nuclear reactor, pipe line bends joining two pipes carrying heavy water and other components require welding for safe and reliable operations.

**Defence Industry:**

Defence industry requires welding for joining of many components of war equipment. Tank bodies fabrication, joining of turret mounting to main body of tanks are typical examples of applications of welding.

**Micro-Joining:**

It employs the processes such as micro-plasma, ultrasonic, laser and electron beam welding, for joining of thin wire to wire, foil to foil and foil to wire, such as producing junctions of thermocouples, strain gauges to wire leads etc.

Apart from above applications welding is also used for joining of pipes, during laying of crude oil and gas pipelines, construction of tankers for their storage and transportation. Offshore structures, dockyards, loading and unloading cranes are also produced by welding.

## Classification of Welding Processes:

Welding processes can be classified based on following criteria;

1. Welding with or without filler material.
2. Source of energy of welding.
3. Arc and Non-arc welding.
4. Fusion and Pressure welding.

1. Welding can be carried out with or without the application of filler material. Earlier only gas welding was the fusion process in which joining could be achieved with or without filler material. When welding was done without filler material it was called 'autogenous welding'. However, with the development of TIG, electron beam and other welding processes such classification created confusion as many processes shall be falling in both the categories.
2. Various sources of energies are used such as chemical, electrical, light, sound, mechanical energies, but except for chemical energy all other forms of energies are generated from electrical energy for welding. So this criterion does not justify proper classification.
3. Arc and Non-arc welding processes classification embraces all the arc welding processes in one class and all other processes in other class. In such classification it is difficult to assign either of the class to processes such as electroslag welding and flash butt welding, as in electroslag welding the process starts with arcing and with the melting of sufficient flux the arc extinguishes while in flash butt welding tiny arcs i.e. sparks are established during the process and then components are pressed against each other. Therefore, such classification is also not perfect.
4. Fusion welding and pressure welding is most widely used classification as it covers all processes in both the categories irrespective of heat source and welding with or without filler material. In fusion welding all those processes are included where molten metal solidifies freely while in pressure welding molten metal if any is retained in confined space under pressure (as may be in case of resistance spot welding or arc stud welding) solidifies under pressure or semisolid metal cools under pressure. This type of classification poses no problems so it is considered as the best criterion.

Processes falling under the categories of fusion and pressure welding are shown in Figures 2.1 and 2.2.

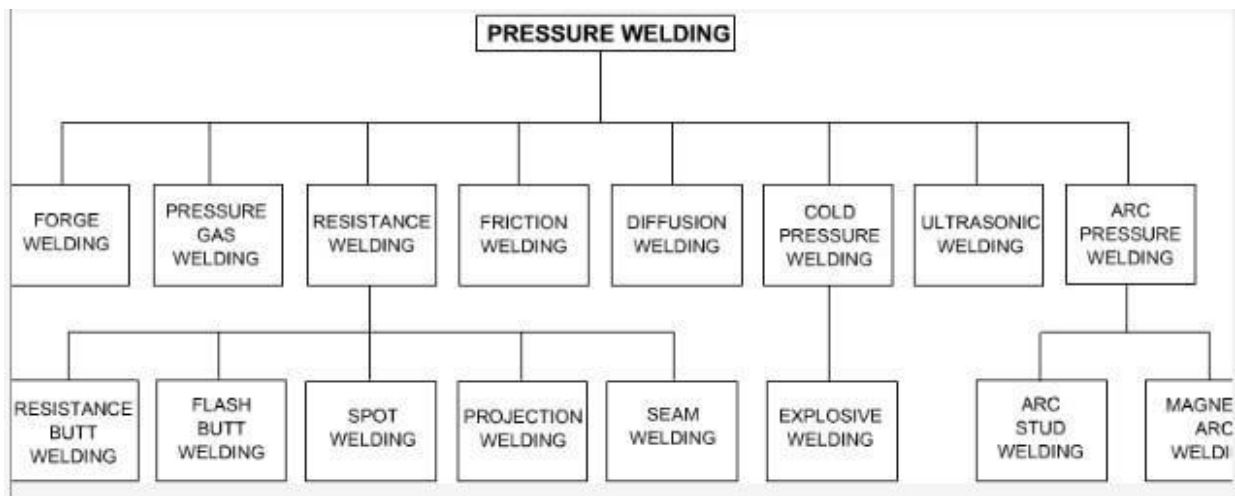
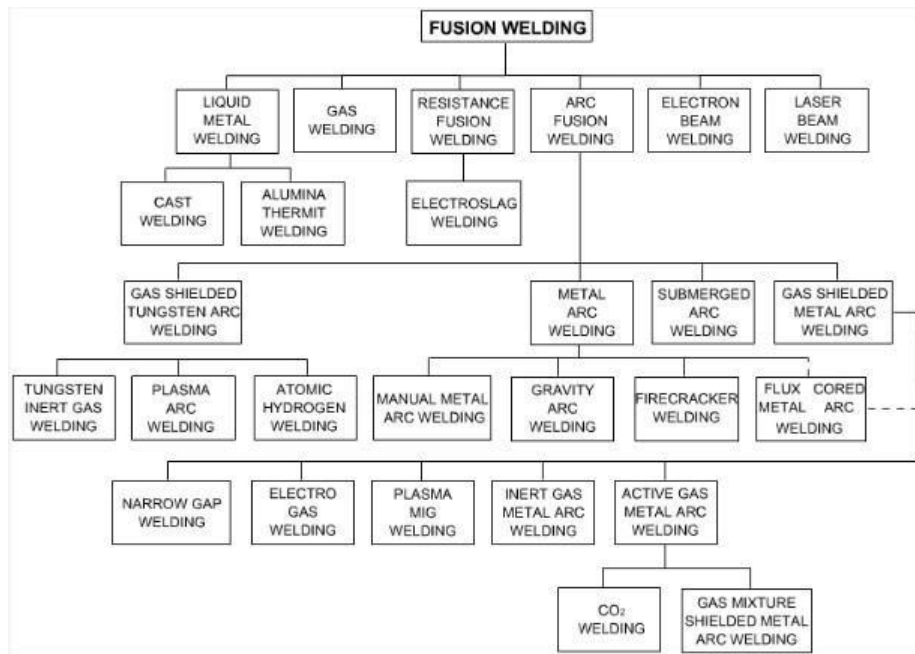

### Design of Welded joints

The performance of weld joints is determined by not only the load resisting cross sectional area of joint but also properties of region close to the weld metal i.e. heat affected zone (HAZ). The design engineer must keep in mind that HAZ can be significantly wider or stronger than weld and so accordingly various parameters of weld joint design should be established. This module based on design of weld joints has been covered in next nine lectures (Lecture 22 to 30). This chapter describes the fundamentals of weld joint design including the parameters that are obtained after designing a weld joint. Keywords: Modes of failure, rigidity and stiffness, loading condition, welding symbol, type of weld and weld joint.

**Introduction** Weld joints may be subjected to variety of loads ranging from a simple tensile load to the complex combination of torsion, bending and shearing loads depending upon the service conditions. The capability of weld joints to take up a given load comes from metallic continuity across the members being joined. Mechanical properties of the weld metal and load resisting cross section area of the weld (besides heat affected zone characteristics) are two most important parameters which need to be established for designing a weld joint.

**Modes of failure of the weld joints** A poorly designed weld joint can lead to the failure of an engineering component in three ways namely a) elastic deformation (like bending or torsion of shaft and other sophisticated engineering systems like precision measuring instruments and machine tools) of weld joint beyond acceptable limits, b) plastic deformation (change in dimensions beyond acceptable limits as-decided by application) of engineering component across the weld joint and c) fracture of weld joint into two or more pieces under external tensile, shear, compression, impact creep and fatigue loads. Therefore, depending upon the application, failure of weld joints may occur in different ways and hence a different approaches are needed for designing the weld joints as per application and service requirements.

**Design of weld joints and mechanical properties** Stiffness and rigidity are important parameters for designing weld joints where elastic deformation is to be controlled. Under such conditions, weld metal of high modulus of elasticity ( $E$ ) and rigidity ( $G$ ) is deposited for producing weld joints besides selecting suitable load resisting cross sectional area. When the failure criterion for a weld joint is the plastic deformation, then weld joints are designed on the basis of yield strength of the weld metal. When the failure criterion for weld joint is to avoid fracture under static loading, then ultimate strength of the weld metal is used as a basis for design. While under fatigue and creep conditions design of weld joints is based on specialized approaches which will be discussed in later stages of this chapter. Under simplified conditions, design for fatigue loads is based on endurance limit. Weld joints invariably possess different types of weld discontinuities of varying sizes which can be very crucial in case of critical applications e.g. weld joints used in nuclear reactors, aerospace and space craft components. Therefore, weld joints for critical applications are designed using fracture mechanics approach which takes into account the size of discontinuity (in form of crack, porosity or inclusions), applied stresses and weld material properties (yield strength and fracture toughness) in design of weld joints.

**Factors affecting the performance of the weld joints** It is important to note that the mechanical performance of the weld joints is governed by not only mechanical properties of the weld metal and its load resisting cross sectional area (as mentioned above) but also on the welding procedure used for developing a weld joint which includes the edge preparation, weld joint design, and type of weld, number of passes, preheat and post weld heat treatment, if any, welding process and welding parameters (welding current, arc length, welding speed) and method used for protecting the weld contamination from atmospheric gases. As most of the above mentioned steps of welding procedure influence

metallurgical properties and residual stresses in weld joint which in turn affect the mechanical (tensile and fatigue) performance of the weld joint.  
Design of weld joints and loading conditions

Design of weld joints for static and dynamic loads needs different approaches because in case of static loads the direction and magnitude become either constant or changes very slowly while in case of dynamic loads such as impact and fatigue conditions, the rate of loading is usually high. In case of fatigue loading both magnitude and direction of load may fluctuate. Under the static load condition, low rate of loading increases the time available for localized yielding to occur in area of high stress concentration which in turn causes stress relaxation by redistribution of stresses through-out the cross section while under dynamic loading conditions, due to lack of availability of time, yielding across the section of weld doesn't take place and only localized excessive deformation occurs near the site of a high concentration stress which eventually provide an easy site for nucleation and growth of cracks as in case of fatigue loading.

**Need of welding symbols** It is important to communicate information about welding procedure without any ambiguity to all those who are involved in various steps of fabrication of successful weld joints ranging from edge preparation to final inspection and testing of welds. To assist in this regard, standard symbols and methodology for representing the welding procedure and other conditions have been developed. Symbols used for showing the type of weld to be made are called weld symbols. Some common weld symbols are shown below in Fig. 22.1.

Basic Welding Symbols									
BEAD	FILLET	PLUG OR SLOT	GROOVE OR BUTT						
			SQUARE	V	BEVEL	U	J	FLARE V	FLARE BEVEL

### Basic Weld Symbols

Symbols which are used to show not only the type of weld but all relevant aspects related with welding like size & location of weld, welding process, edge preparation, bead geometry and weld inspection process and location of the weld to be fabricated and method of weld testing etc. are called welding symbols. Following sections present standard terminologies and joints used in field of welding engineering. 22.7 Types of weld Joints the classification of weld joints is based on the orientation of plates/members to be welded. Common types of weld joints and their schematics are shown in Fig. 22.2 (a-e). Butt joint: plates are in same horizontal plane and aligned with maximum deviation of 5°. Lap joint: plates overlapping each other and the overlap can just one side or both the sides of plates being welded Corner joint: joint is made by melting corners of two plates being welded and therefore plates are approximately perpendicular (75° - 90°) to each other at one side of the plates being welded Edge joint: joint is made by melting the edges of two plates to be welded and therefore the plates are almost parallel (0° - 5°)

T joint: one plate is approximately perpendicular to another plate (85° - 90°)



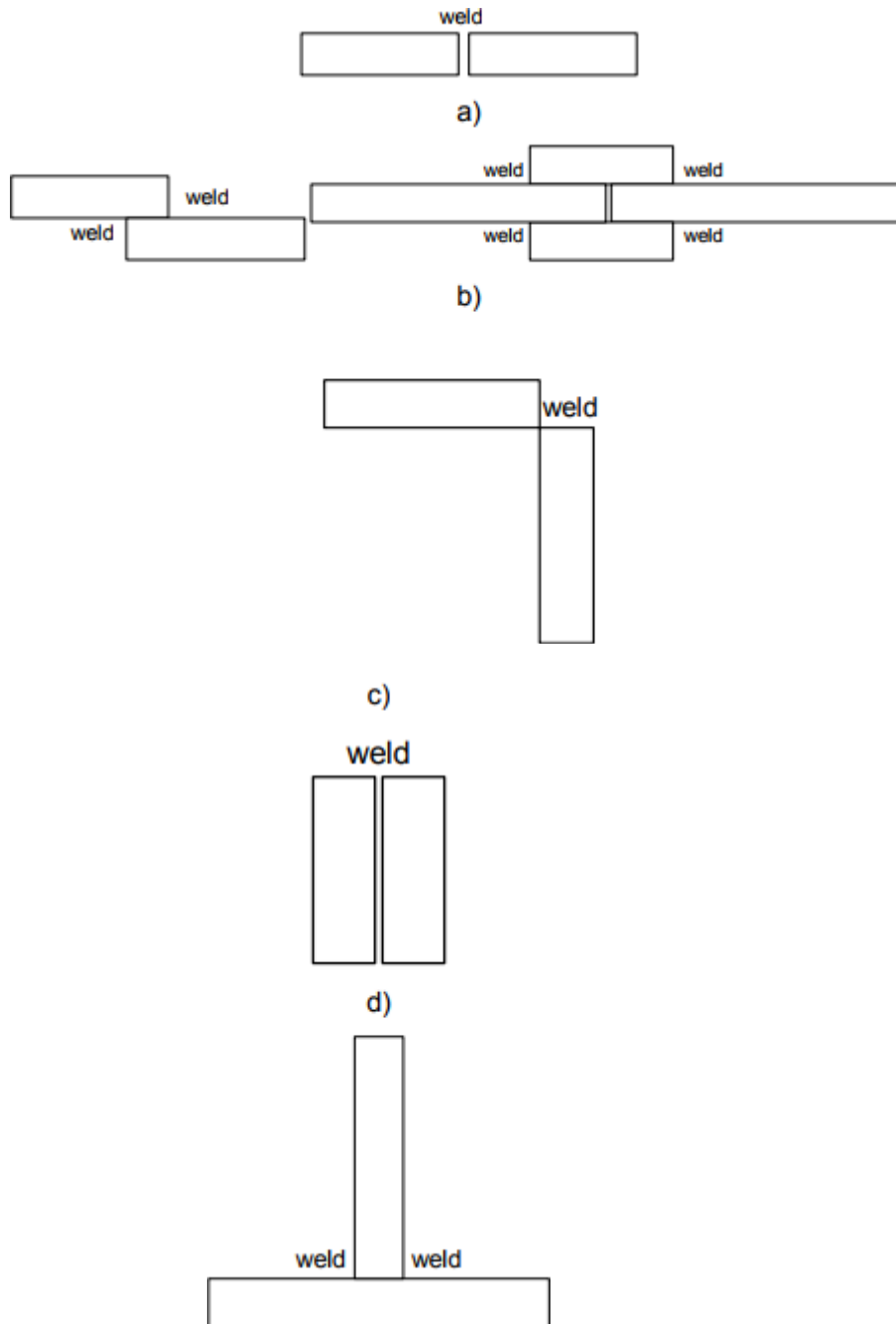

Schematic of different types of weld joints a) Butt b) Lap c) Corner d) Edge and e) T- Joint

3.0 Types of weld This classification is based on the combined factors like “how weld is made” and “orientation of plates” to be welded. Common types of weld joints and their schematics are shown in Fig. 22.3 (a-e).

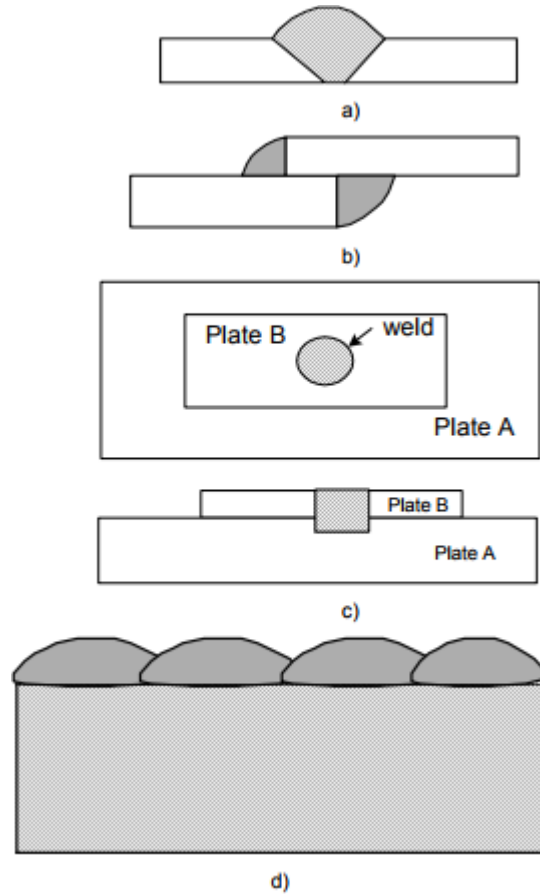

Schematic of different types of welds a) Groove b) Fillet c) Plug and d) Bead on Plate

### Gas Metal Arc Welding

Gas metal arc welding (GMAW) is the process in which arc is struck between bare wire electrode and workpiece. The arc is shielded by a shielding gas and if this is inert gas such as argon or helium then it is termed as metal inert gas (MIG) and if shielding gas is active gas such as CO<sub>2</sub> or mixture of inert and active gases then process is termed as metal active gas (MAG) welding. Figure 9.1 illustrates the process of GMA welding.

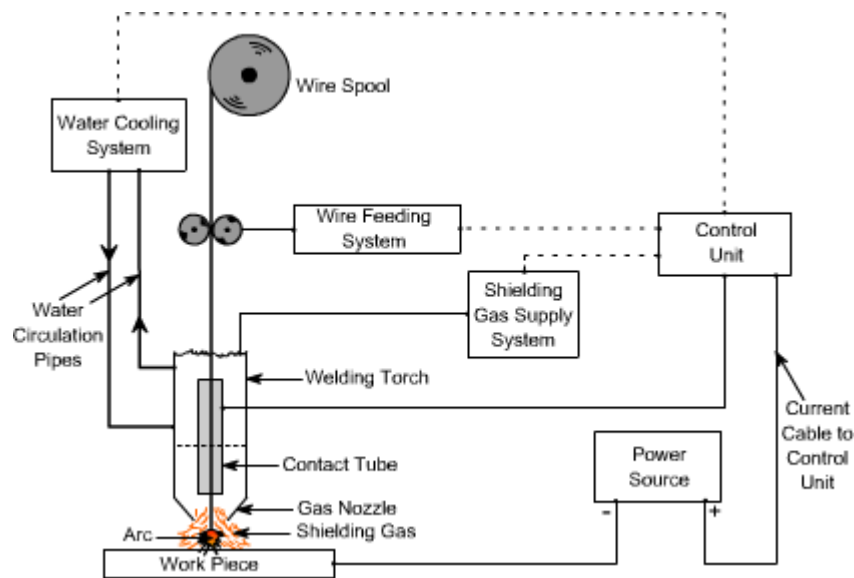

Schematic Diagram of GMA Welding

Direct current flat characteristic power source is the requirement of GMAW process. The electrode wire passing through the contact tube is to be connected to positive terminal of power source so that stable arc is achieved. If the electrode wire is connected to negative terminal then it shall result into unstable spattery arc leading to poor weld bead. Flat characteristic leads to self adjusting or self regulating arc leading to constant arc length due to relatively thinner electrode wires.

GMA welding requires consumables such as filler wire electrode and shielding gas. Solid filler electrode wires are normally employed and are available in sizes 0.8, 1.0, 1.2 and 1.6 mm diameter. Similar to submerged arc welding electrode wires of mild steel and low alloyed steel, are coated with copper to avoid atmospheric corrosion, increase current carrying capacity and for smooth movement through contact tube. The electrode wire feeding system is shown in Figure 9.2.

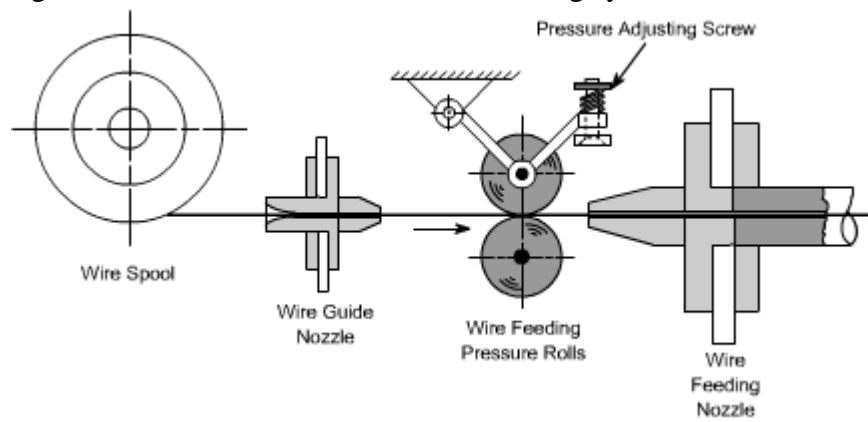

Electrode Wire Feeding System

Pressure adjusting screw is used to apply required pressure on the electrode wire during its feeding to avoid any slip. Depending on the size and material of the wire, different pressures are required for the smooth feeding of wire with minimum deformation of the wire. Further, wire feeding rolls have grooves of different sizes and are to be changed for a particular wire size.

The range of welding current and voltage vary and is dependent on material to be welded, electrode size and mode of metal transfer i.e. mode of molten drop formed at the tip of electrode and its transfer to the weld pool. This process exhibits most of the metal transfer modes depending on welding parameters.

The range of current and voltage for a particular size of electrode wire, shall change if material of electrode wire is changed. With lower currents normally lower voltages are employed while higher voltages are associated with higher currents during welding. Thin sheets and plates in all positions or root runs in medium plates are welded with low currents while medium and heavy plates in flat position are welded with high currents and high voltages. Welding of medium thickness plates in horizontal and vertical positions are welded with medium current and voltage levels.

Table 9.1 gives the total range of currents and voltages for different sizes of structural steel i.e. mild steel electrodes of different sizes.

<b>Electrode Wire Diameter (mm)</b>	<b>Current Range (A)</b>	<b>Voltage Range (V)</b>
0.8	50-180	14-24
1.0	70-250	16-26
1.2	120-320	17-30
1.6	150-380	18-34

**Table 9.1: Welding Current and Voltage Ranges for Mild Steel Electrodes**

Both inert gases like argon and helium and active gases like CO<sub>2</sub> and N<sub>2</sub> are being used for shielding depending upon the metal to be welded. Mixtures of inert and active gases like CO<sub>2</sub> and O<sub>2</sub> are also being used in GMA welding process. For mild steel carbon dioxide is normally used which gives high quality, low current out of position welding i.e. also in welding positions other than flat position. Low alloyed and stainless steels require argon plus oxygen mixtures for better fluidity of molten metal and improved arc stability. The percentage of oxygen varies from 1-5% and remaining is argon in argon and oxygen mixtures. However, low alloy steels are also welded with 80% argon and 20% CO<sub>2</sub> mixture.

Nickel, monel, inconel, aluminum alloys, magnesium, titanium, aluminum bronze and silicon bronze are welded with pure argon. Nickel and nickel alloys may sometimes be welded with mixture of argon and hydrogen (upto 5%). Copper and aluminum are also welded with 75% helium and 25% argon mixture to encounter their thermal conductivity. Nitrogen may be used for welding

of copper and some of its alloys, but nitrogen and argon mixtures are preferred over pure nitrogen for relatively improved arc stability.

The process is extremely versatile over a wide range of thicknesses and all welding positions for both ferrous and nonferrous metals, provided suitable welding parameters and shielding gases are selected. High quality welds are produced without the problem of slag removal. The process can be easily mechanized / automated as continuous welding is possible.

However, process is costly and less portable than manual metal arc welding. Further, arc shall be disturbed and poor quality of weld shall be produced if air draught exists in working area.

GMA welding has high deposition rate and is indispensable for welding of ferrous and specially for nonferrous metals like aluminum and copper based alloys in shipbuilding, chemical plants, automobile and electrical industries. It is also used for building structures.

This chapter presents the basic principle of arc welding processes with focus on shielded metal arc welding. Further, the influence of welding parameters on performance of weld joint and the role of coating on electrode have been described. Keywords: Arc welding, shielded metal arc welding, shielding in SMAW, electrode coating, welding current, electrode size

Arc Welding Process All arc welding processes apply heat generated by an electric arc for melting the faying surfaces of the base metal to develop a weld joint (Fig. 11.1). Common arc welding processes are manual metal or shielded metal arc welding (MMA or SMA), metal inert gas arc (MIG), tungsten inert gas (TIG), submerged arc (SA), plasma arc (PA), carbon arc (CA) selding etc.

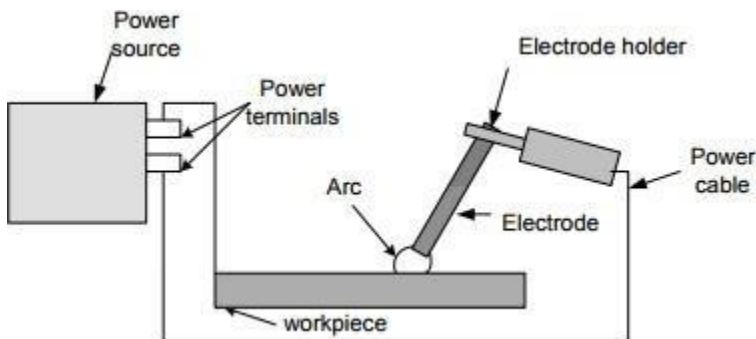

Schematic diagram showing various elements of SMA welding system

## Forge Welding

### Principle

As we discussed, forge welding is a solid state welding process in which both the plates are heated quite below its melting temperature. This heating deforms the work pieces plastically. Now a repeated hammering or high pressurize load is applied on these plates together. Due to this high pressure and temperature, inter-molecular diffusion takes place at the interface surface of the plates which make a strong weld joint. This is basic principle of forge welding. One of the basic

requirement of this [types of welding](#), is clean interface surface which should be free from oxide or other contaminant particles. To prevent the welding surface from oxidation, flux is used which mixes with the oxide and lower down its melting temperature and viscosity. This allow to flow out the oxide layer during heating and hammering process.

### Working

Forge welding was one of the most applied welding method in ancient time. This is a fundamental welding process of all solid state welding. Its working can be summarized as follow.

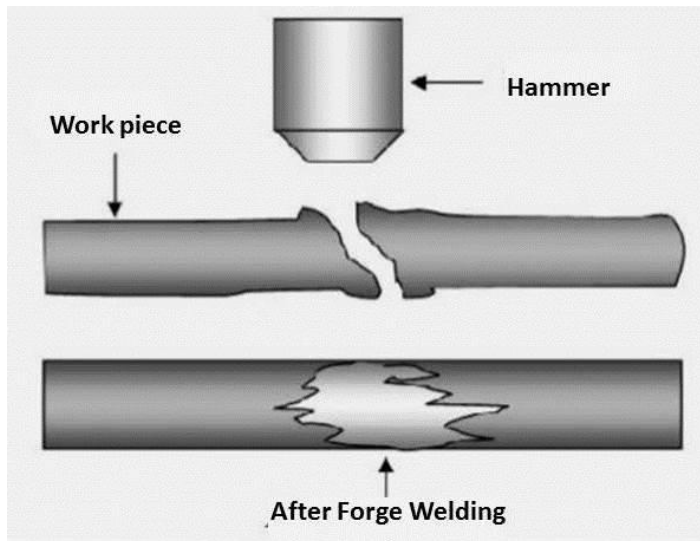

- First both the work plates heated together. The heating temperature is about 50 to 90% of its melting temperature. Both the plates are coated with flux.
- Now manual hammering is done by a blacksmith [hammer](#) for making a joint. This process is repeated until a proper joint is created.
- For welding large work pieces, mechanical hammering is used which is either driven by electric motor or by using hydraulic mean. Sometime dies are used which provides finished surface.

### Application

- It is used to join steel or iron.
- It is used to manufacture gates, prison cells etc.
- It is widely used in cookware.
- It was used to join boiler plates before introduction of other welding process.
- It was used to weld weapon like sword etc.
- Used to weld shotgun barrels.

### Advantages

- It is simple and easy.
- It does not require any costly equipment for weld small pieces.

- It can weld both similar and dissimilar metals.
- Properties of weld joint is similar to base material.
- No filler material required.

#### Disadvantages

- Only small objects can be weld. Larger objects required large press and heating furnaces, which are not economical.
- High skill required because excessive hammering can damage the welding plates.
- High [Welding defects](#) involve.
- It cannot use as mass production.
- Mostly suitable for iron and steel.
- It is a slow welding process.

#### Resistance Welding

Resistance welding processes are pressure welding processes in which heavy current is passed for short time through the area of interface of metals to be joined. These processes differ from other welding processes in the respect that no fluxes are used, and filler metal rarely used. All resistance welding operations are automatic and, therefore, all process variables are preset and maintained constant. Heat is generated in localized area which is enough to heat the metal to sufficient temperature, so that the parts can be joined with the application of pressure. Pressure is applied through the electrodes.

The heat generated during resistance welding is given by following expression:

$H = I^2 R T$
Where, <b>H</b> is heat generated
<b>I</b> is current in amperes
<b>R</b> is resistance of area being welded
<b>T</b> is time for the flow of current.

The process employs currents of the order of few KA, voltages range from 2 to 12 volts and times vary from few ms to few seconds. Force is normally applied before, during and after the flow of current to avoid arcing between the surfaces and to forge the weld metal during post heating. The necessary pressure shall vary from 30 to 60 N mm<sup>-2</sup> depending upon material to be welded and other welding conditions. For good quality welds these parameters may be properly selected which shall depend mainly on material of components, their thicknesses, type and size of electrodes.

Apart from proper setting of welding parameters, component should be properly cleaned so that surfaces to be welded are free from rust, dust, oil and grease. For this purpose components may be given pickling treatment i.e. dipping in diluted acid bath and then washing in hot water bath and then in the cold water bath. After that components may be dried through the jet of compressed air. If surfaces are rust free then pickling is not required but surface cleaning can be done through some solvent such as acetone to remove oil and grease.

The current may be obtained from a single phase step down transformer supplying alternating current. However, when high amperage is required then three phase rectifier may be used to obtain DC supply and to balance the load on three phase power lines.

The material of electrode should have higher electrical and thermal conductivities with sufficient strength to sustain high pressure at elevated temperatures. Commonly used electrode materials are pure copper and copper base alloys. Copper base alloys may consist of copper as base and alloying elements such as cadmium or silver or chromium or nickel or beryllium or cobalt or zirconium or tungsten. Pure tungsten or tungsten-silver or tungsten-copper or pure molybdenum may also be used as electrode material. To reduce wear, tear and deformation of electrodes, cooling through water circulation is required. Figure 11.1 shows the water cooling system of electrodes.

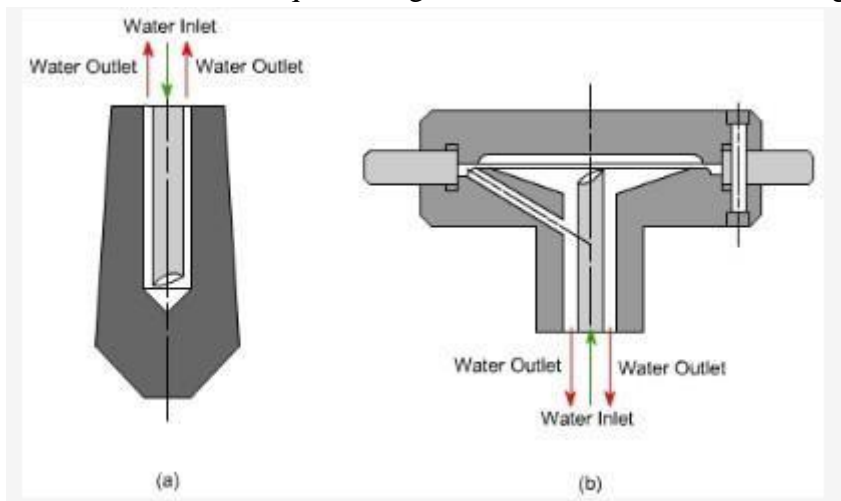

Water Cooling Electrodes a)Spot Welding b) Seam Welding

Commonly used resistance welding processes are spot, seam and projection welding which produce lap joints except in case of production of welded tubes by seam welding where edges are in butting position. In butt and flash welding, components are in butting position and butt joints are produced.

### 1. Spot Welding

In resistance spot welding, two or more sheets of metal are held between electrodes through which welding current is supplied for a definite time and also force is exerted on work pieces. The principle is illustrated in Figure 11.2.



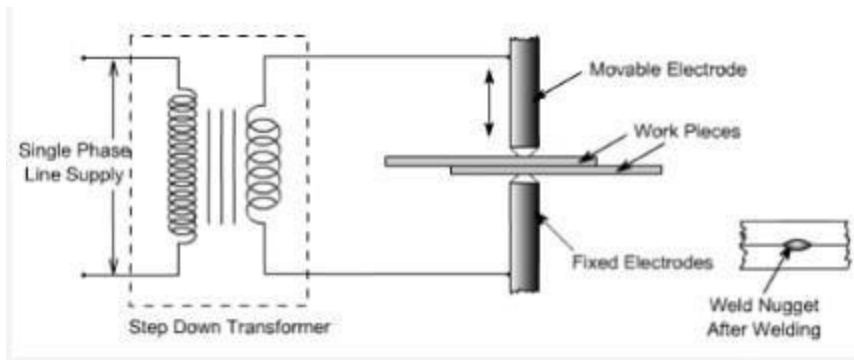

The welding cycle starts with the upper electrode moving and contacting the work pieces resting on lower electrode which is stationary. The work pieces are held under pressure and only then heavy current is passed between the electrodes for preset time. The area of metals in contact shall be rapidly raised to welding temperature, due to the flow of current through the contacting surfaces of work pieces. The pressure between electrodes, squeezes the hot metal together thus completing the weld. The weld nugget formed is allowed to cool under pressure and then pressure is released. This total cycle is known as resistance spot welding cycle and illustrated in Figure 11.3

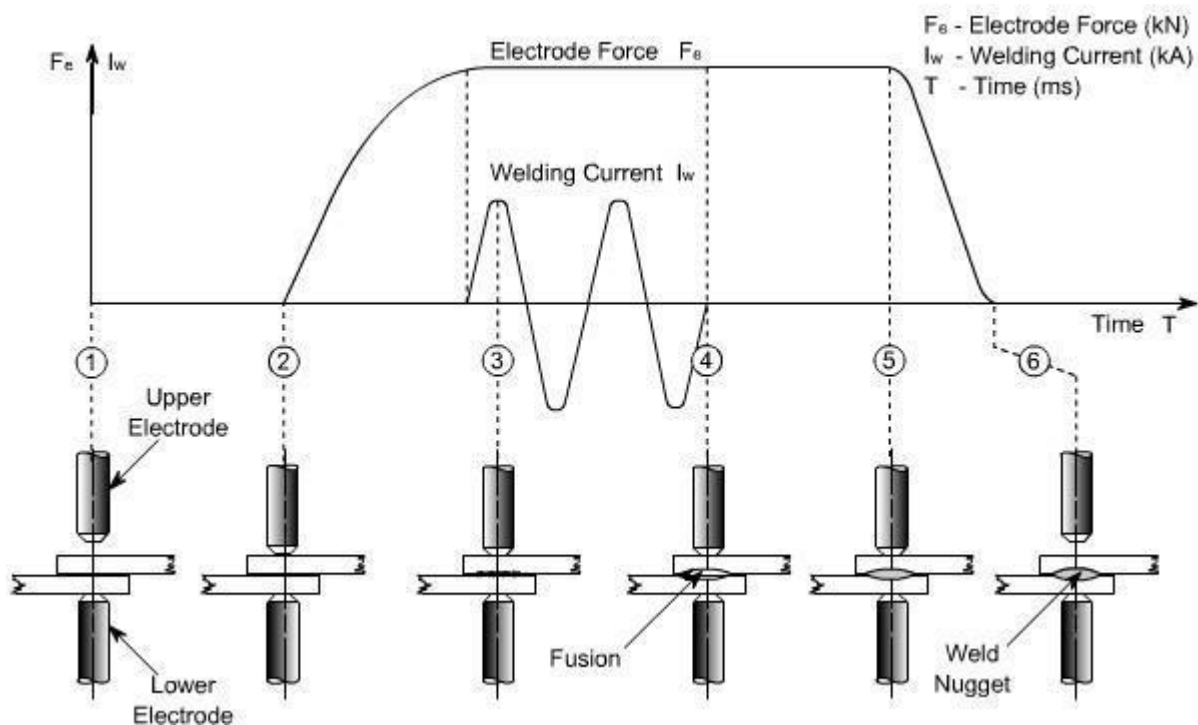

Spot welding electrodes of different shapes are used. Pointed tip or truncated cones with an angle of  $120^\circ - 140^\circ$  are used for ferrous metal but with continuous use they may wear at the tip. Domed electrodes are capable of withstanding heavier loads and severe heating without damage and are normally useful for welding of nonferrous metals. The radius of dome generally varies from 50-100 mm. A flat tip electrode is used where minimum indentation or invisible welds are desired.

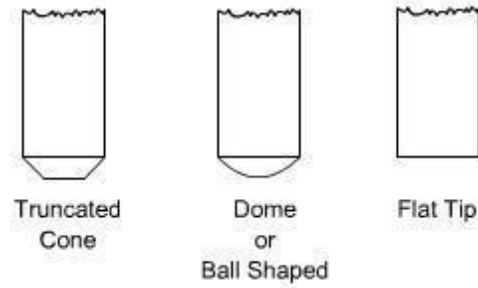
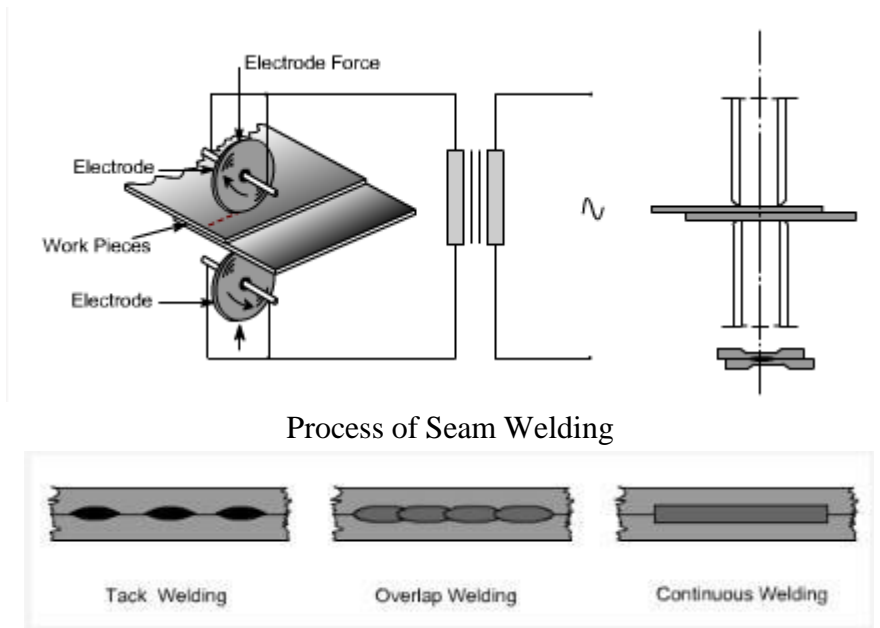

**Fig 11.4: Electrode Shapes for Spot Welding**

Most of the industrial metal can be welded by spot welding, however, it is applicable only for limited thickness of components. Ease of mechanism, high speed of operation and dissimilar metal combination welding, has made it widely applicable and acceptable process. It is widely being used in electronic, electrical, aircraft, automobile and home appliances industries.

**2. Seam Welding:**

In seam welding overlapping sheets are gripped between two wheels or roller disc electrodes and current is passed to obtain either the continuous seam i.e. overlapping weld nuggets or intermittent seam i.e. weld nuggets are equally spaced. Welding current may be continuous or in pulses. The process of welding is illustrated in Figure 11.5.



**Types of Seam Welds**

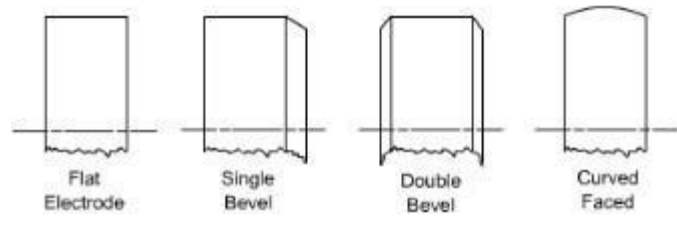

Electrodes shapes of Seam Welding

Overlapping of weld nuggets may vary from 10 to 50 %. When it is approaching around 50 % then it is termed as continuous weld. Overlap welds are used for air or water tightness.

It is the method of welding which is completely mechanized and used for making petrol tanks for automobiles, seam welded tubes, drums and other components of domestic applications.

Seam welding is relatively fast method of welding producing quality welds. However, equipment is costly and maintenance is expensive. Further, the process is limited to components of thickness less than 3 mm.

### 3. Projection Welding:

Projections are little projected raised points which offer resistance during passage of current and thus generating heat at those points. These projections collapse under heated conditions and pressure leading to the welding of two parts on cooling. The operation is performed on a press welding machine and components are put between water cooled copper platens under pressure. Figures 11.8 and 11.9 illustrate the principle of resistance projection welding.

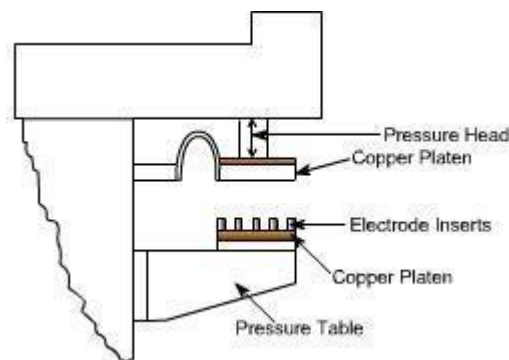

**Fig 11.8: Resistance Projection Welding Machine**

These projections can be generated by press working or machining on one part or by putting some external member between two parts. Members such as wire, wire ring, washer or nut can be put between two parts to generate natural projection.

Insert electrodes are used on copper platen so that with continuous use only insert electrodes are damaged and copper platen is safe. Relatively cheaper electrode inserts can be easily replaced whenever these are damaged.

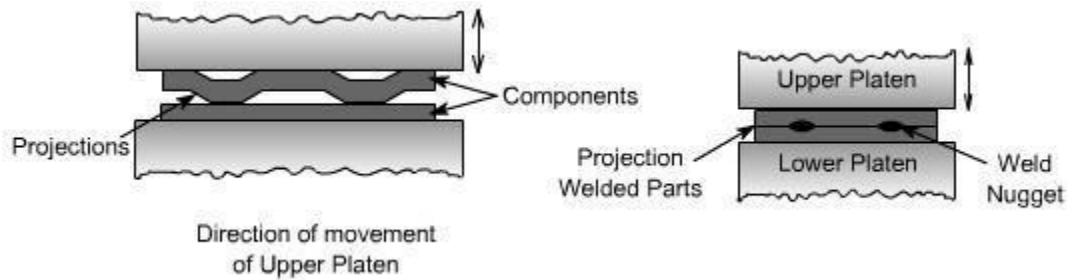

**Fig 11.9: Formation of Welds from Projections on Components**

Projection welding may be carried out with one projection or more than one projections simultaneously.

No consumables are required in projection welding. It is widely being used for fastening attachments like brackets and nuts etc to sheet metal which may be required in electronic, electrical and domestic equipment.

### **Production of seam welded Tubes:**

Welded tubes are produced by resistance seam welding. Tubes are produced from strips which are wrapped on spool with trimmed edges. The width of strip should be slightly bigger than the periphery of the tube to be produced to take care for the loss of metal in flashout. The strip is fed through set of forming rollers to form first the shape of the tube and then it is passed under the seam welding rolls. Under seam welding rolls the edges are butt welded with some flash out on the joint. This flash out is trimmed and then tubes are cut to required size. The process is shown in Figures 11.10 & 11.11.



**Fig 11.10: Forming of Tube from Strip**

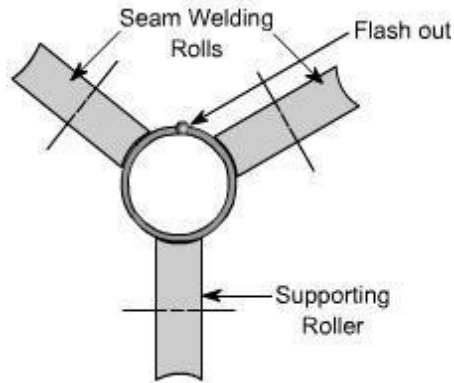

**Fig 11.11: Seam Welding of Tube**

**Thermit Welding:**

After reading this article you will learn about:- 1. Process of Thermit Welding 2. Operation of Thermit Welding 3. Application and Uses 4. Advantages 5. Disadvantages.

**Process of Thermit Welding:**

Thermit welding is a chemical welding process in which an exothermic chemical reaction is used to supply the essential heat energy. That reaction involves the burning of Thermit, which is a mixture of fine aluminum powder and iron oxide in the ratio of about 1:3 by weight.

Although a temperature of 3000°C may be attained as a result of the reaction, preheating of the Thermit mixture up to about 1300°C is essential in order to start the reaction.

**The mixture reacts according to the chemical reaction:**

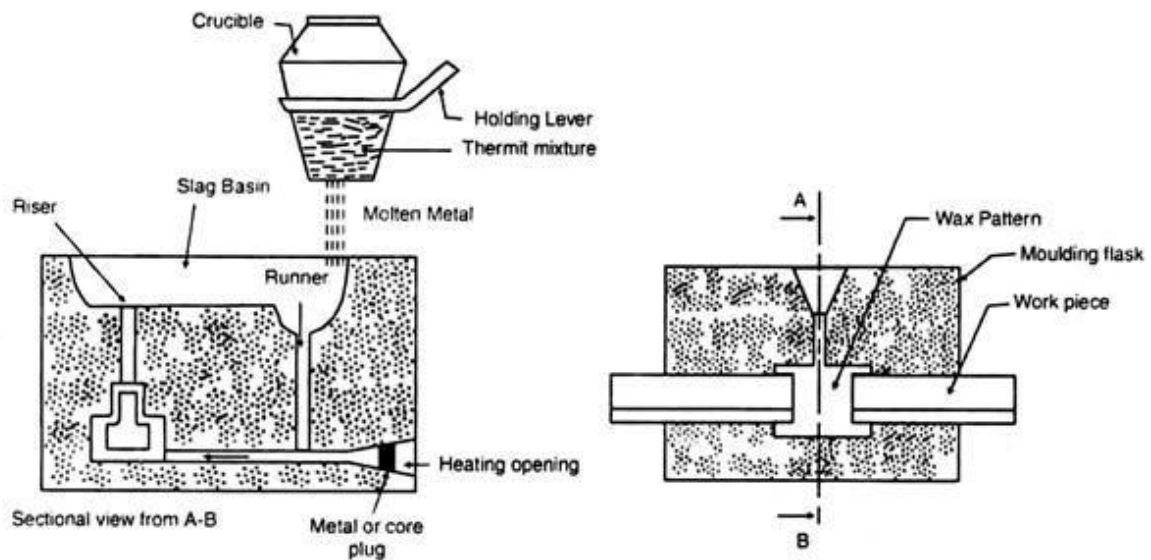
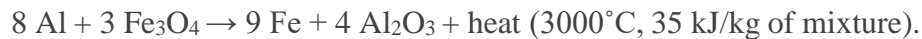

**Fig. 7.40. Thermit welding.**

Aluminum has greater affinity to react with oxygen; it reacts with ferric oxide to liberate pure iron and slag of aluminum oxide. Aluminum oxide floats on top of molten metal pool in the form of slag and pure iron (steel) settled below, because of large difference in densities.

### **Operation of Thermit Welding:**

#### **ADVERTISEMENTS:**

Thermit welding process is essentially a casting and foundry process, where the metal obtained by the Thermit reaction is poured into the refractory cavity made around the joint.

#### **The various steps involved in Thermit welding are:**

1. The two pieces of metal to be joined are properly cleaned and the edge is prepared.
2. Then the wax is poured into the joint so that a wax pattern is formed where the weld is to be obtained.
3. A moulding box is kept around the joint and refractory sand is packed carefully around the wax pattern as shown in Fig. 7.40, providing the necessary pouring basin, sprue, and riser and gating system.
4. A bottom opening is provided to run off the molten wax. The wax is melted through this opening which is also used to preheat the joint. This makes it ready for welding.
5. The Thermit is mixed in a crucible which is made of refractory material that can withstand the extreme high heat and pressure, produced during the chemical reaction.
6. The igniter (normally barium peroxide or magnesium) is placed on top of the mixture and is lighted with a red hot metal rod or magnesium ribbon.
7. The reaction takes about 30 seconds and highly super-heated molten iron is allowed to flow into the prepared mould cavity around the part to be welded.
8. The super-heated molten metal fuses the parent metal and solidifies into a strong homogeneous weld.
9. The weld joint is allowed to cool slowly.

There are different Thermit mixtures available for welding different metals, such as copper and chromium. They use different metal oxides in place of ferrous oxide. Some typical Thermit mixture reactions with their temperature obtained are given below:

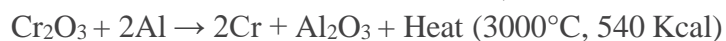

### **Application and Uses of Thermit Welding:**

Thermit welding is a very old process and now-a-days, in most cases, it is replaced by electro-slag welding. However, this process is still in use.

#### **Some applications are:**

- (i) Thermit welding is traditionally used for the welding of very thick and heavy plates.
- (ii) Thermit welding is used in joining rail roads, pipes and thick steel sections.
- (iii) Thermit welding is also used in repairing heavy castings and gears.
- (iv) Thermit welding is suitable to weld large sections such as locomotive rails, ship hulls etc.
- (v) Thermit welding is used for welding cables made of copper.

### **Advantages of Thermit Welding:**

1. Thermit welding is a simple and fast process of joining similar or dissimilar metals.
2. This process is cheap, as no costly power supply is required.
3. This process can be used at the places where power supply is not available.

### **Disadvantages of Thermit Welding:**

1. Thermit welding is essentially used for ferrous metal parts of heavy sections.
2. It is uneconomical for welding cheap metals and light parts.

### **Plasma Arc Welding**

**Introduction** The plasma arc welding (PAW) can be considered as an advanced version of TIG welding. Like TIGW, PAW also uses the tungsten electrode and inert gases for shielding of the molten metal. Low velocity plasma and diffused arc is generated in the TIG welding while in case of PAW very high velocity and coherent plasma is generated. Large surface area of the arc exposed to ambient air and base metal in case of TIG welding causes greater heat losses than PAW and lowers the energy density. Therefore, TIG arc burns at temperature lower than plasma arc.

**Principle of PAW** In plasma arc welding, arc is forced to pass through nozzle (water cooled copper) which causes the constriction of the arc (Fig. 16.5). Constriction of arc results in (a) reduction in cross-sectional area of arc, (b) increases (d) increases energy density and (c) increases to velocity of plasma approaching to the sound velocity and temperature to about 25000 0 C. these factors together make PAW, a high energy density and low heat input welding process therefore; it poses fewer which in turn reduces problems associated with weld thermal cycle.

Constriction of arc increases the penetration and reduces the width of weld bead. Energy associated with plasma depends on plasma current, size of nozzle, plasma gas (Fig. 16.6). A coherent, columnar and stiff plasma is formed due to constriction therefore it doesn't get deflected and diffused. Hence, heat is transferred to the base metal over a very small area which in turns results in high energy density and deep of penetration and small width of the weld pool / key hole / cut. Further, stiff and coherent plasma makes it possible to work having stable arc with very low current levels (<15A) which in turn has led to micro-plasma system.

Energy density and penetration capability of plasma jet is determined by the various process parameters namely plasma current, nozzle orifice diameter and shape, plasma forming gas (Air, He, Ar) and flow rate of plasma carrying. Increasing plasma current, flow rate, thermal conductivity of plasma forming gas and reducing nozzle orifice diameter increases together result in the energy density and penetration capability of plasma jet. In general, the plasma cutting uses high energy density in combination with high plasma velocity and high flow rate of high thermal conductivity plasma forming gas. A combination of such characteristics for plasma cutting is achieved by controlling above process parameters. Further, thermal conductivity of plasma forming gas must be high enough for cutting operation so that heat can be effectively transferred

rapidly to the base metal. Plasma arc welding needs comparatively low energy density and low velocity plasma to avoid melt through or blowing away tendency of molten metal.

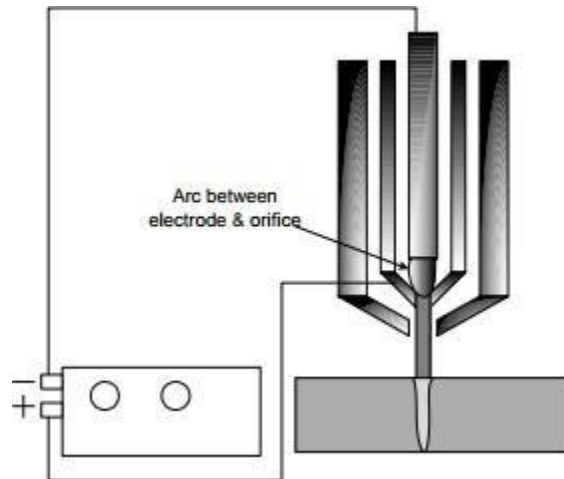

Schematic of plasma arc welding system showing important components

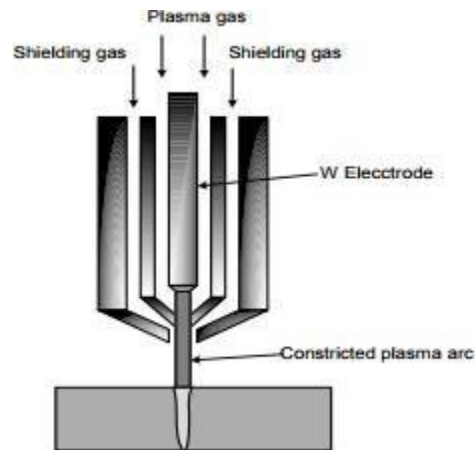

Schematic of constriction of arc in PAW

High energy density associated with plasma arc produces a temperature of order of 25,000 °C. This process uses the heat transferred by plasma (high temperature charged gas column) produced by a gas (Ar, Ar-H<sub>2</sub> mixture) passing through an electric arc, for melting of faying surfaces. Inert gas (Ar, He) is used to protect the molten weld pool from the atmospheric gases. Charged particles (electrons and ions) formed as a result of ionization of plasma gas tends to reunite when they strike to the surface of work piece. Recombination of charged particles liberates heat which is also used in melting of base metal. Electric arc can be produced between nonconsumable electrode and work-piece or non-consumable electrode and nozzle. As discussed above, plasma arc welding uses two types of gases one is called plasma gas and other is inert gas primarily for shielding the weld pool from the contamination by atmospheric gases. Plasma gas is primarily used to develop plasma by passing through arc zone and transfer the heat to the weld pool.



PAW uses the constant current type power source with DCEN polarity. The DCEN polarity is invariably used in PAW because tungsten electrode is used for developing the arc through which plasma forming gas is passed. Tungsten electrode has good electron emitting capability therefore it is made cathode. Further, DCEN polarity causes less thermal damage to the electrode during welding as about one third of total heat is generated at the cathode and balance two-third of arc heat is generated at the anode side i.e. work-piece. DCEP polarity does not help the process in either way. Current can vary from 2-200 A.

The plasma arc in PAW is not initiated by the conventional touch start method but it heavily depend on use of high frequency unit. Plasma is generated using two cycles approach a) producing very small high-intensity spark (pilot arc) within the torch body by imposing pulses of high voltage, high frequency and low current about 50A (from HF unit) between the electrode and nozzle which in turn generates a small pocket of plasma gas and then as soon as torch approaches the work-piece main current starts flowing between electrode and job leading to the ignition of the transferred arc. At this stage pilot is extinguished and taken off the circuit.

**Types of PAW** Plasma generated due to the arc between the non-consumable electrode and workpiece is called transferred plasma whereas that due to arc between non-consumable electrode and nozzle is called non-transferred plasma. Non-transferred plasma system to a large extent becomes independent of nozzle to work piece distance.

Transferred plasma offers higher energy density than non-transferred plasma and therefore it is preferred for welding and cutting of high speed steel, ceramic, aluminium etc. Non-transferred plasma is usually applied for welding and thermal spray application of steel and other common metals. Depending upon the current, plasma gas flow rate, and the orifice diameter following variants of PAW has been developed such as:

Micro-plasma (< 15 Amperes) •

Melt-in mode (15–400 Amperes) plasma arc •

Keyhole mode (>400 Amperes) plasma arc

Micro-plasma welding systems work with very low plasma forming current (generally lower than 15 A) which in turn results in comparatively low energy density and low plasma velocity. These conditions become good enough to melt thin sheet for plasma welding.

Plasma for melt-in mode uses somewhat higher current and greater plasma velocity than micro-plasma system for welding applications. This is generally used up to 2.4 mm thickness sheet. For thickness of sheet greater than 2.5 mm normally welding is performed using key-hole technique. The key hole technique uses high current and high pressure plasma gas to ensure key-hole formation. High energy density of plasma melts the faying surfaces of base metal and high pressure plasma jet pushes the molten metal against vertical wall created by melting of base metal and developing key-hole. Plasma velocity should be such that it doesn't push molten metal out of the hole. The key is formed under certain combination of plasma current, orifice gas flow rate and velocity of plasma welding torch and any disturbance to above parameters will cause loss of key-

hole. For key-holing, flow rate is very crucial and therefore is controlled accurately + 0.14 liter/min. Nozzles are specified with current and flow rate.

### **Advantage of PAW**

With regard to energy density, PAW stands between GTAW/GMAW and EBW/LBW accordingly it can be used using melt-in mode and key-hole mode. Melt-in mode results in greater heat input and higher width to depth of weld ratio than key-hole mode. Higher energy density associated with PAW than GTAW produces narrow heat affected zone and lowers residual stress and distortion related problems. High depth to width ratio of weld produced by PAW reduces the angular distortion. It generally uses about one tenth of welding current as compared to GTAW for same thickness therefore it can be effectively applied for joining of the thin sheets. Further, non-transferred plasma offers flexibility of variation in standoff distance between nozzle and work-piece without extinction of the arc.

### **Limitation of PAW**

Infrared and ultra-violet rays generated during the PA welding are found harmful to human being. High noise (100dB) associated with PAW is another undesirable factor. PAW is a more complex, costlier, difficult to operate than GTAW besides generating high noise level during welding. Narrow width of the PAW weld can be problematic from alignment and fit-up point of view. Productivity of the PAW in respect of welding speed is found lower than LBW.

### **Oxy-Fuel Gas Cutting:**

This is the most frequently employed thermal cutting process used for low carbon and low alloy steel plates and often referred to as 'flame cutting' or 'gas cutting'. It can be used to cut steel upto 2 m thick.

Oxy-fuel gas process involves preheating a small zone, wherefrom the cut is to be started, to the kindling temperature of the material. Compressed oxygen is then made to impinge upon the hot metal resulting in very high rate of oxidation which is often accompanied by evolution of heat due to exothermic nature of the reaction.

The fuel gas employed is generally acetylene but propane, LPG (liquefied petroleum gas), natural gas, or methylacetylene propadiene stabilised (MAPP or MPS) may also be employed depending upon availability and cost considerations.

The torch employed for oxy-acetylene cutting is shown in Fig. 19.2. It has a mixing chamber for oxygen and acetylene as in a welding torch. But after mixing the gas mixture flows out of the torch nozzle through a number of small holes placed in a circle around the central hole through which a stream of high pressure pure oxygen can be made to flow by pressing a lever on the torch handle. The diameter of these holes vary and increases with increase in thickness of the material to be cut.

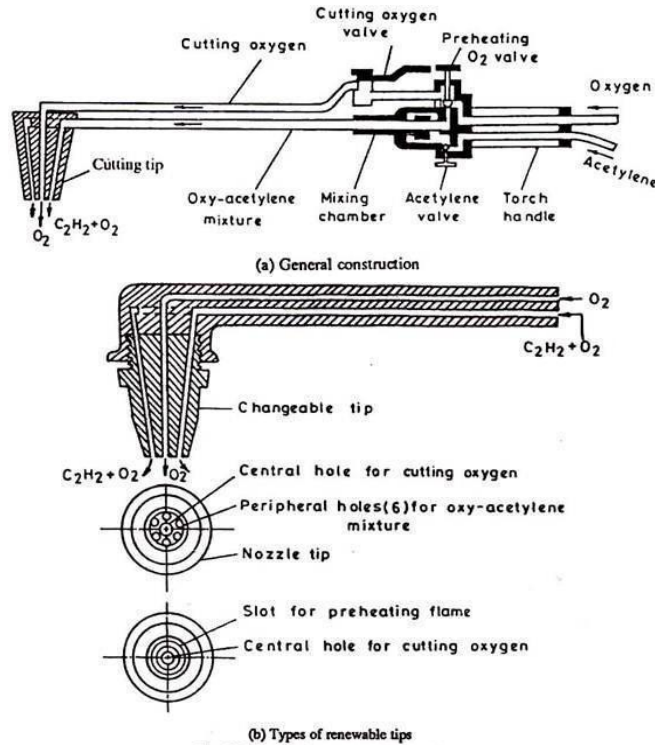

(b) Types of renewable tips  
 Fig. 19.2 Gas cutting torch and types of tips.

When the material to be cut is raised to its kindling temperature\* (which is 870 to 950°C for low carbon steels, depending upon the carbon content) and high pressure pure oxygen reacts with it, the following reactions are possible in the case of ferrous materials.

1.  $\text{Fe} + \text{O} \rightarrow \text{FeO} + \text{heat} \text{ (267 KJ)} \dots\dots\dots(19.1)$
2.  $2\text{Fe} + 1.5\text{O}_2 \rightarrow \text{Fe}_2\text{O}_3 + \text{heat} \text{ (825 KJ)} \dots\dots\dots(19.2)$
3.  $3\text{Fe} + 2\text{O}_2 \rightarrow \text{Fe}_3\text{O}_4 + \text{heat} \text{ (1120KJ)} \dots\dots\dots(19.3)$

Mainly third reaction takes place with tremendous release of heat. Second reaction occurs to some extent in cutting of heavier sections only. Theoretically 0.29 m<sup>3</sup> of O<sub>2</sub> will oxidise 1 kg of iron to form Fe<sub>3</sub>O<sub>4</sub>. However, in practice the consumption of oxygen is higher than this value for plate thickness less than 40 mm and it is lower for higher thicknesses, being the least for the thickness range of 100 to 125 mm.

The exothermic reaction between O<sub>2</sub> and Fe generates enough heat to continue the thermal cutting process without the use of preheating flame using only oxygen but in practice it is not possible because a lot of heat is used up in burning dirt, paint, scale, etc., and a considerable amount is lost by radiation. Also, the high speed jet impinging upon the surface causes cooling action which needs to be compensated by preheating.

The chemical reaction between ferrous and oxygen is rarely complete and the analysis of the blown out material (or slag) often indicates that 30% to 40% of the slag is parent material.

**Steel and some other metals can be cut by oxy-acetylene flame if they fulfill the following conditions:**

- (1) The melting point of the metal should be higher than its kindling temperature.

(2) The metal oxide formed by reaction with oxygen should have lower melting point than the melting point of the parent material and it should be fluid in molten state so as to blow out easily.

(3) It should have low thermal conductivity so that the material can be rapidly raised to its kindling temperature.

When a workpiece is cut by a thermal cutting process, the width of the cut is referred to as KERF, which in oxy-fuel gas process is a function of oxygen hole size in the nozzle tip, flowrate of oxygen and preheating gases, speed of cutting and the nature of the material being cut.

### Cutting of Ferrous and Non-Ferrous Metals:

#### Metal Powder Cutting:

It is an oxygen cutting process in which metal powder (iron or aluminum) is employed to facilitate cutting. This process is used for cutting cast iron, chromium-nickel, stainless steel and some high alloy steels. The working principle of powder cutting is like injection of metal powder into the oxygen stream well before it strikes the metal to be cut.

The powder is heated by its passage through the oxy-acetylene preheat flames and almost immediately ignites in the stream of cutting oxygen. The powder from a powder dispenser is carried to the lip of the cutting torch by the use of compressed air or nitrogen as shown in Fig. 19.7.

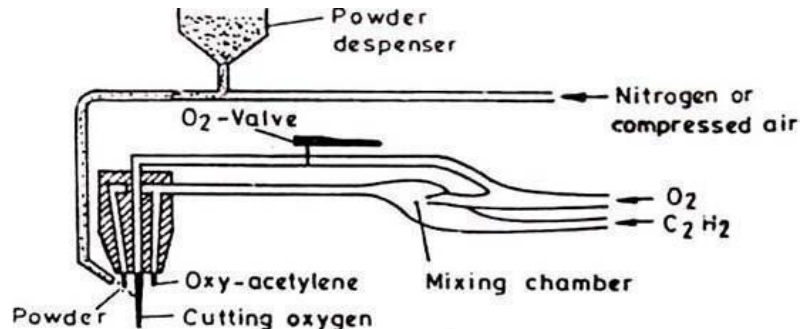

Fig. 19.7 Cutting torch for metal powder cutting.

The ignited powder provides much higher temperature in the stream and that helps in cutting the metal in almost the same manner as cutting of low carbon steel. Preheating is not essential for powder cutting.

Cutting speeds and cutting oxygen pressures are similar to those for cutting mild steel; however for cutting material thicker than 25 mm a nozzle one size larger should be used. Flow rates are generally kept at 0.10 to 0.25 kg of iron powder per minute of cutting. Powder cutting usually leaves a scale on the cut surface which can be easily removed on cooling.

Metal powder cutting was initially introduced for cutting stainless steel but has been successfully used for cutting alloy steels, cast iron, bronze, nickel, aluminium, steel mill ladle spills, certain

refractories, and concrete. The same basic process can also be used for gouging and scarfing to condition billets, blooms, and slabs in steel mills.

Powder cutting is also useful for stack cutting wherein preheat from an ordinary flame cutting is not sufficient on the lower plate(s) either due to large depth or separation between plates. By means of the metal powder and its reaction in the oxygen the cut is completed even across separations. However, powder cutting generates quite a bit of smoke that needs to be removed to safeguard the health of the operator and to avoid interference with other operations in the area.

### Process # 3. Chemical Flux Cutting:

In the oxygen-cutting process a chemical flux is injected into the oxygen stream as metal powder is injected in powder cutting. The flux combines with the refractory oxides and makes them a soluble compound. The chemical fluxes may be salts of sodium such as sodium carbonate.

Fig. 19.8 shows one of the setups used for flux cutting. In this method oxygen sucks flux from a hopper at the rate of 0.06 to 0.30 kg per minute and flows through the jet of cutting oxygen.

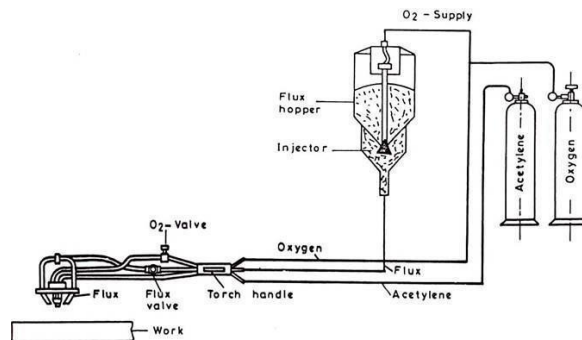

Fig. 19.8 A setup for cutting with chemical flux.

The procedure for flux cutting involves heating the initiating point of cut to white heat, the cutting oxygen valve is then opened half-turn and the flux in oxygen stream is led to the torch. As the molten metal reaches the lower edge of the work, the torch is made to move along the line of the cut and the cutting oxygen valve is fully opened. To halt the operation first flux-supply valve is closed and then the other torch valves are shut-off.

It is advisable to position the flux-supply 10 m away from the cutting area. It should also be ensured that the hoses through which the flux-oxygen mixture is passed have no sharp bends otherwise it may lead to clogging.

This process can be used for cutting cast iron, chromium-steel, chromium-nickel steel, copper, brass and bronze. However, it is not recommended for cutting steels of high-nickel type, for example, 15 Cr 35Ni steel. Chemical flux cutting, however, is slowly losing its industrial importance because of the development of more efficient methods like plasma cutting.

Metal Inert Gas (MIG) Welding (also known as Gas Metal Arc Welding [GMAW]) is an [arc welding](#) technique in which a [consumable electrode](#) is used to weld two or more workpieces. A diagrammatic representation of metal inert gas [welding](#) is shown below:

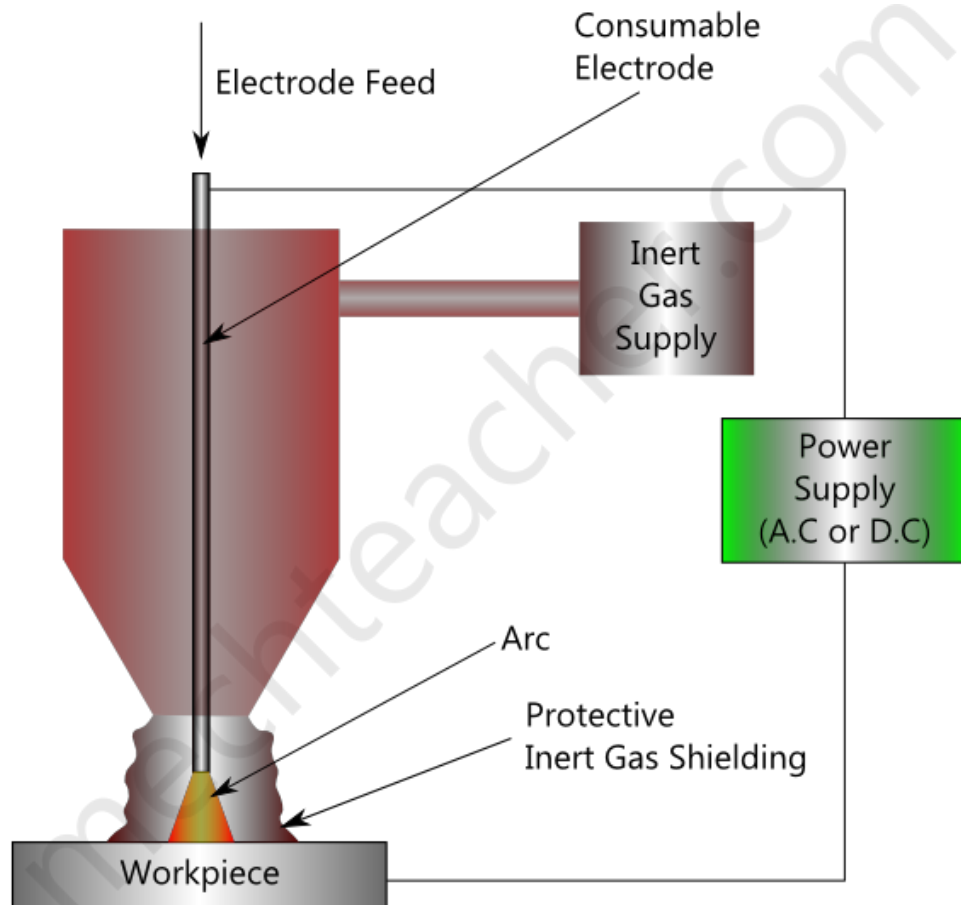

Components used in Metal Inert Gas Welding (MIG Welding):

Metal Inert Gas Welding (MIG Welding) makes use of the following components:

1. Consumable Electrode
2. Inert Gas Supply
3. Welding Head
4. A.C or D.C Power Supply
5. Electrode Feeding Mechanism

Working:

The workpiece to be welded and the consumable [electrode](#) (in the form of wire) are connected to the Power Supply (D.C or A.C). Whenever the consumable electrode is brought near the workpiece

(with a small air gap), an arc is produced. This arc melts the electrode. The melted electrode fills uniformly over the required regions of the workpiece.

An inert gas supply is provided around the electrode (hence the name 'Metal Inert Gas Welding') during the welding process. It forms a gas shield around the arc and the weld (See the [diagram above](#)). This is intended to protect the weld from the external atmosphere.

The type of electrode used and the shielding gas used primary depends on the material to be welded. In many cases the shielding gas used is a mixture of many gases.

If many workpieces are to be welded continuously an electrode spool (in the form of coil) is used. Consumable electrode is continuously supplied from this spool by a suitable feeding mechanism. Commonly, servo mechanisms are used for feeding long electrodes.

In MIG Welding, consumable electrode itself acts as filler metal. So, no separate filler rod or filler wire is needed.

Advantages of Metal Inert Gas Welding (MIG Welding):

1. Consumable electrodes are easy to feed.
2. No filler rod is needed.
3. Welding is simple.
4. Inert gas shield protects the weld automatically.

Disadvantages of Metal Inert Gas Welding (MIG Welding):

1. Improper welding may lead to the floating of solid impurities over the liquid weld.
2. If not handled properly, weld may become porous.
3. MIG Welding exposes welders to hazardous gases.
4. Care must be taken to avoid the formation of less ductile welds.
5. Work pieces and Electrodes should be kept clean before welding.

### **TIG Welding**

Tungsten Inert Gas (TIG) or Gas Tungsten Arc (GTA) welding is the arc welding process in which arc is generated between non consumable tungsten electrode and workpiece. The tungsten electrode and the weld pool are shielded by an inert gas normally argon and helium. Figures 10.1 & 10.2 show the principle of tungsten inert gas welding process.



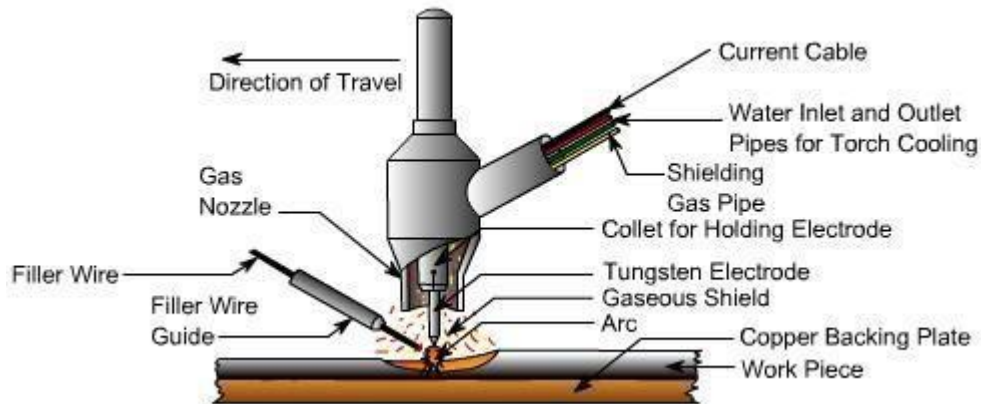

**Fig 10.1: Principle of TIG Welding.**

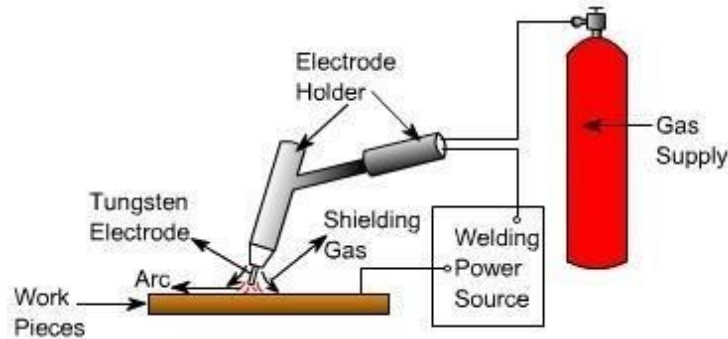

**Fig 10.2: Schematic Diagram of TIG Welding System.**

The tungsten arc process is being employed widely for the precision joining of critical components which require controlled heat input. The small intense heat source provided by the tungsten arc is ideally suited to the controlled melting of the material. Since the electrode is not consumed during the process, as with the MIG or MMA welding processes, welding without filler material can be done without the need for continual compromise between the heat input from the arc and the melting of the filler metal. As the filler metal, when required, can be added directly to the weld pool from a separate wire feed system or manually, all aspects of the process can be precisely and independently controlled i.e. the degree of melting of the parent metal is determined by the welding current with respect to the welding speed, whilst the degree of weld bead reinforcement is determined by the rate at which the filler wire is added to the weld pool.

In TIG torch the electrode is extended beyond the shielding gas nozzle. The arc is ignited by high voltage, high frequency (HF) pulses, or by touching the electrode to the workpiece and withdrawing to initiate the arc at a preset level of current.

Selection of electrode composition and size is not completely independent and must be considered in relation to the operating mode and the current level. Electrodes for DC welding are pure tungsten or tungsten with 1 or 2% thoria, the thoria being added to improve electron emission which facilitates easy arc ignition. In AC welding, where the electrode must operate at a higher temperature, a pure tungsten or tungsten-zirconia electrode is preferred as the rate of tungsten loss



is somewhat lesser than with thoriated electrodes and the zirconia aids retention of the 'balled' tip.

Table 10.1 gives chemical composition of tungsten electrodes as per American Welding Society (AWS) classification.

<b>AWS Classification</b>	<b>Tungsten, min. percent</b>	<b>Thoria, percent</b>	<b>Zirconia, percent</b>	<b>Total other elements, max. percent</b>
EWP	99.5	-	-	0.5
EWTh-1	98.5	0.8 to 1.2	-	0.5
EWTh-2	97.5	1.7 to 2.2	-	0.5
EWZr	99.2	-	0.15 to 0.40	0.5

**Table 10.1: Chemical Composition of TIG Electrodes.**

Tungsten electrodes are commonly available from 0.5 mm to 6.4 mm diameter and 150 - 200 mm length. The current carrying capacity of each size of electrode depends on whether it is connected to negative or positive terminal of DC power source. AC is used only in case of welding of aluminum and magnesium and their alloys. Table 10.2 gives typical current ranges for TIG electrodes when electrode is connected to negative terminal (DCEN) or to positive terminal (DCEP).

<b>Electrode Dia. (mm)</b>	<b>DCEN</b>	<b>DCEP</b>
	<b>Pure and Thoriated Tungsten</b>	<b>Pure and Thoriated Tungsten</b>
0.5	5-20	-
1.0	15-80	-
1.6	70-150	10-20
2.4	150-250	15-30
3.2	250-400	25-40
4.0	400-500	40-55
4.8	500-750	55-80
6.4	750-1000	80-125

**Table 10.2: Typical Current Ranges for TIG Electrodes**

The power source required to maintain the TIG arc has a drooping or constant current characteristic which provides an essentially constant current output when the arc length is varied over several millimeters. Hence, the natural variations in the arc length which occur in manual welding have little effect on welding current. The capacity to limit the current to the set value is equally crucial when the electrode is short circuited to the workpiece, otherwise excessively high current shall flow, damaging the electrode. Open circuit voltage of power source ranges from 60 to 80 V.

Argon or helium may be used successfully for most applications, with the possible exception of the welding of extremely thin material for which argon is essential. Argon generally provides an arc which operates more smoothly and quietly, is handled more easily and is less penetrating than the arc obtained by the use of helium. For these reasons argon is usually preferred for most applications, except where the higher heat and penetration characteristic of helium is required for welding metals of high heat conductivity in larger thicknesses. Aluminum and copper are metals of high heat conductivity and are examples of the type of material for which helium is advantageous in welding relatively thick sections.

Pure argon can be used for welding of structural steels, low alloyed steels, stainless steels, aluminum, copper, titanium and magnesium. Argon hydrogen mixture is used for welding of some grades of stainless steels and nickel alloys. Pure helium may be used for aluminum and copper. Helium argon mixtures may be used for low alloy steels, aluminum and copper.

TIG welding can be used in all positions. It is normally used for root pass(es) during welding of thick pipes but is widely being used for welding of thin walled pipes and tubes. This process can be easily mechanised i.e. movement of torch and feeding of filler wire, so it can be used for precision welding in nuclear, aircraft, chemical, petroleum, automobile and space craft industries. Aircraft frames and its skin, rocket body and engine casing are few examples where TIG welding is very popular.

### **Friction Welding:**

#### **Principle:**

Friction welding works on basic principle of friction. In this welding process, the friction is used to generate heat at the interference surface. This heat is further used to join two work pieces by applying external pressure at the surface of work piece. In this welding process, the friction is applied until the plastic forming temperature is achieved. It is normally 900-1300 degree centigrade for steel. After this heating phase, a uniformly increasing pressure force applied until the both metal work pieces makes a permanent joint. This joint is created due to thermo mechanical treatment at the contact surface.

#### **Working:**

There are many types of friction welding processes which works differently. But all different these processes involves common a working principle which can be summarize as follow.

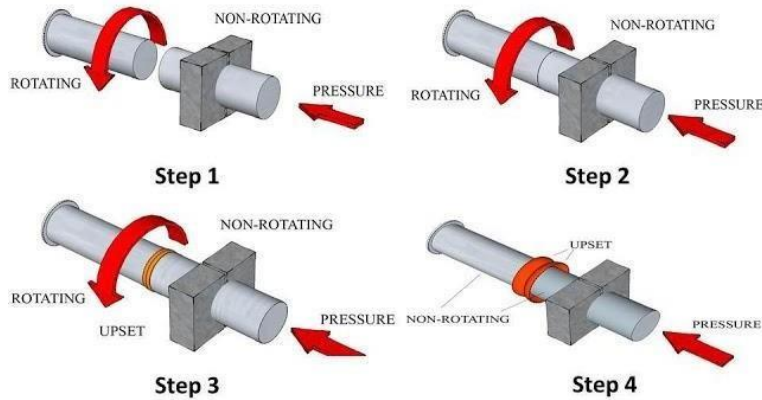

### Friction Welding

- First both the work pieces are prepared for smooth square surface. One of them is mounted on a rotor driven chuck and other one remains stationary.
- The rotor allows rotating at high speed thus it makes rotate mounted work piece. A little pressure force is applied on the stationary work piece which permits cleaning the surface by burnishing action.
- Now a high pressure force applied to the stationary work piece which forces it toward rotating work piece and generates a high friction force. This friction generates heat at the contact surface. It is applied until the plastic forming temperature is achieved.
- When the temperature is reached the desire limit, the rotor is stopped and the pressure force is applied increasingly until the whole weld is formed.
- This welding is used to weld those metals and alloys which cannot be welded by other method.

Types:

Continuous induce friction welding:

This welding is same as we discussed above. In this welding process, the rotor is connected with a band [brake](#). When the friction crosses the limit of plastic temperature, the band brake comes into action which stops the rotor but the pressure applied on the work piece increasingly until the weld is formed.

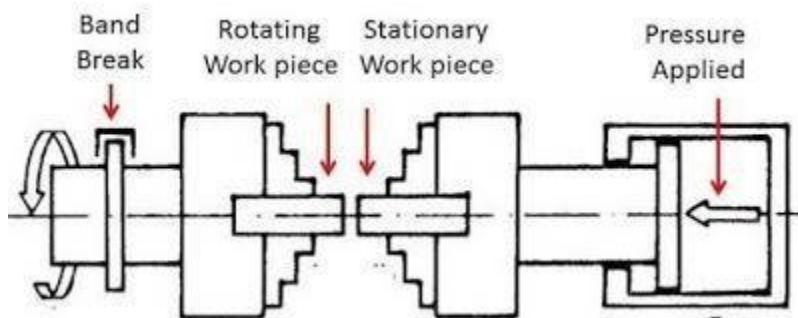

Inertia friction welding:

In this type of friction welding the band brake is replaced by the **engine** flywheel and shaft flywheel. These flywheels connect chuck to the motor. In the starting of the welding, both flywheels are connected with one another. When the speed or friction reaches its limit, the engine flywheel separated from the shaft flywheel. Shaft flywheel has low moment of inertia which stops without brake. The pressure force is continuously applied to the work piece until the weld is formed.

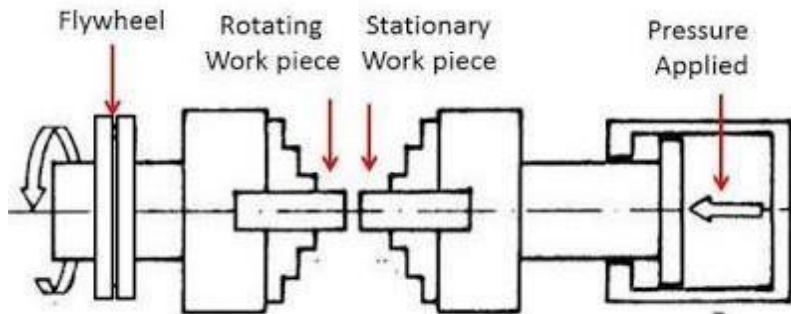

#### Application:

- For welding tubes and shafts.
- It is mostly used in aerospace, **automobile**, marine and oil industries.
- Gears, axle tube, valves, **drive line** etc. components are friction welded.
- It is used to replace **forging** or **casting** assembly.
- Hydraulic piston rod, truck rollers bushes etc. are join by friction welding.
- Used in electrical industries for welding copper and aluminum equipment's.
- Used in pump for welding pump shaft (stainless steel to carbon steels).
- Gear levers, drill bits, connecting rod etc. are welded by friction welding.

#### Advantages and Disadvantages:

##### Advantages:

- It is environment friendly process without generation smoke etc.
- Narrow heat affected zone so no change in properties of heat sensitive material.
- No filler metal required.
- Welding strength is strong in most cases.
- Easily automated.
- High welding speed.
- High efficiency of weld.
- Wide variety of metal can be weld by this process.

##### Disadvantages:

- This is mostly used only for round bars of same cross section.
- Non-forgable material cannot be weld.
- Preparation of work piece is more critical
- High setup cost.
- Joint design is limited.

This is all about friction welding principle, working, types, application, advantages and disadvantages. If you have any query regarding this article, ask by commenting. If you like this article, don't forget to share it on your social networks. Subscribe our website for more interesting articles.

### Explosive Welding:

#### Principle:

This welding process works on basic principle of metallurgical bonding. In this process, a controlled detonation of explosive is used on the welding surface. This explosion generates a high pressure force, which deforms the work plates plastically at the interface. This deformation forms a metallurgical bond between these plates. This metallurgical bond is stronger than the parent materials. The detonation process occurs for a very short period of time which cannot damage the parent material. This is basic principle of explosion welding. This welding is highly dependent on welding parameters like standoff distance, velocity of detonation, surface preparation, explosive etc. This welding is capable to join large area due to high energy available in explosive.

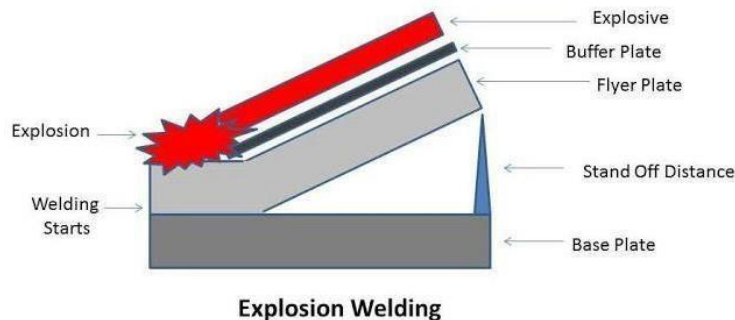

#### Basic terminology:

**Base Plate:** This is one of the welding plate which is kept stationary on a avail. It involves a backer which supports the base plate and minimizes the distortion during the explosion.

**Flyer Plate:** This is another welding plate which is going to be weld on base plate. It has lowest density and tensile yield strength compare to base plate. It is situated parallel or at an angle on the base plate.

**Buffer Plate:** Buffer plate is situated on the flyer plate. This plate is used to minimize the effect or explosion on upper surface of flyer plate. This protects the flyer plate from any damage due to explosion.

**Standoff distance:** Stand-off distance plays a vital role in explosion welding. It is distance between flyer plate and base plate. Generally it is taken double of thickness of flyer plate for thin plates and equal to thickness of flyer plate for thick plates.

**Explosive:** Explosive is placed over the flyer plate. This explosive is situated in a box structure. This box placed on the flyer plate. Mostly RDX, TNT, Lead azide, PETN etc. used as explosive.

**Velocity of detonation:** It is the rate at which the explosive detonate. This velocity should be kept less than 120% of sonic velocity. It is directly proportional to explosive type and its density.

Types:

This welding can be classified into two types according to the setup configuration.

**Oblique Explosion Welding:**

In this type of welding process base plate is fixed on an anvil and filler plate makes an angle with the base plate. This welding configuration is used to join thin and small plates.

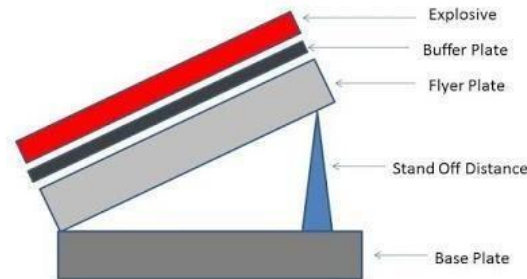

**Oblique Explosion Welding**

**Parallel Explosion Welding:**

As the name implies, in this welding configuration filler plate is parallel to the base plate. There is some standoff distance between base plate and flyer plate. This configuration is used to weld thick and large plates.

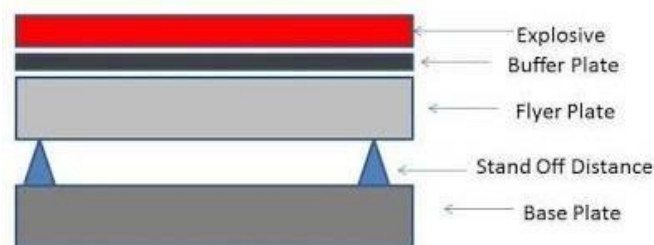

**Parallel Explosion Welding**

Working:

We have discussed about working principle of explosion welding. Its working can be summarized as follow.

- First both the flyer plate and the base plate interface surface are cleaned and prepared for good weld.
- Now the base plate fixed on the avail and the flyer plate place at the top surface of it at a pre-define distance (stand-off distance). The flyer plate may be inclined or parallel according to the welding configuration.
- The buffer plate is set over the flyer plate. This plate protects the upper surface of flyer place from damage due to high impact force of explosion.

- The prepared explosive is placed into a box of same size of welding surface. This box is placed over buffer plate. There is a detonator at one side of the explosive. This is used to start explosion.
- Now the detonator ignites the explosive which creates a high pressure wave. These waves deform the interface surface plastically and form a metallurgical bond between base plate and flyer plate. This bond is stronger than parent material.

#### Application:

- Used to weld large structure sheets of aluminum to stainless steel.
- It is used to weld cylindrical component like pipe, concentric cylinder, tube etc.
- Weld clad sheet with steel in a heat exchanger.
- Join dissimilar metals which cannot be welded by other welding process.
- For joining cooling fan etc.

#### Advantages and Disadvantages:

##### Advantages:

- It can join both similar and dissimilar material.
- Simple in operation and handling.
- Large surface can be welded in single pass.
- High metal joining rate. Mostly time is used in preparation of the welding.
- It does not affect the properties of welding material.
- It is a solid state process so does not involve any filler material, flux etc.

##### Disadvantages:

- It can weld only ductile metal with high toughness.
- It creates a large noise which produces noise pollution.
- Welding is highly dependent on process parameters.
- Higher safety precautions are involved due to explosive.
- Designs of joints are limited.

This is all about explosion welding principle, working, types, application, advantages and disadvantages. If you have any query regarding this article, ask by commenting. If you like this article, don't forget to share it on your social networks. Subscribe our website for more interesting articles.

## Welding Defects

The defects in the weld can be defined as irregularities in the weld metal produced due to incorrect welding parameters or wrong welding procedures or wrong combination of filler metal and parent metal.

Weld defect may be in the form of variations from the intended weld bead shape, size and desired quality. Defects may be on the surface or inside the weld metal. Certain defects such as cracks are never tolerated but other defects may be acceptable within permissible limits. Welding

defects may result into the failure of components under service condition, leading to serious accidents and causing the loss of property and sometimes also life.

Various welding defects can be classified into groups such as cracks, porosity, solid inclusions, lack of fusion and inadequate penetration, imperfect shape and miscellaneous defects.

### 1. Cracks

Cracks may be of micro or macro size and may appear in the weld metal or base metal or base metal and weld metal boundary. Different categories of cracks are longitudinal cracks, transverse cracks or radiating/star cracks and cracks in the weld crater. Cracks occur when localized stresses exceed the ultimate tensile strength of material. These stresses are developed due to shrinkage during solidification of weld metal.

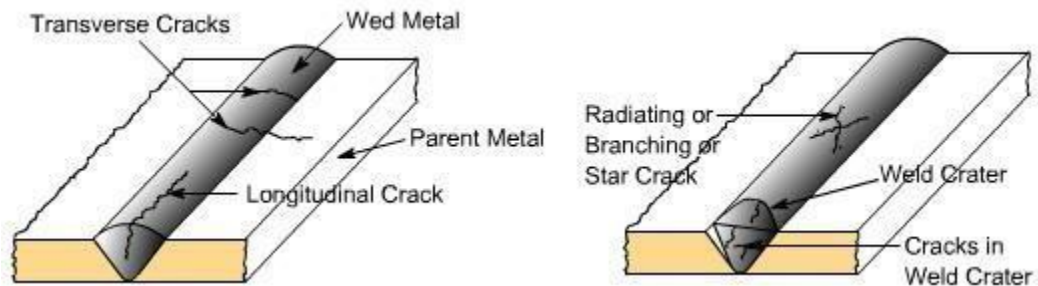
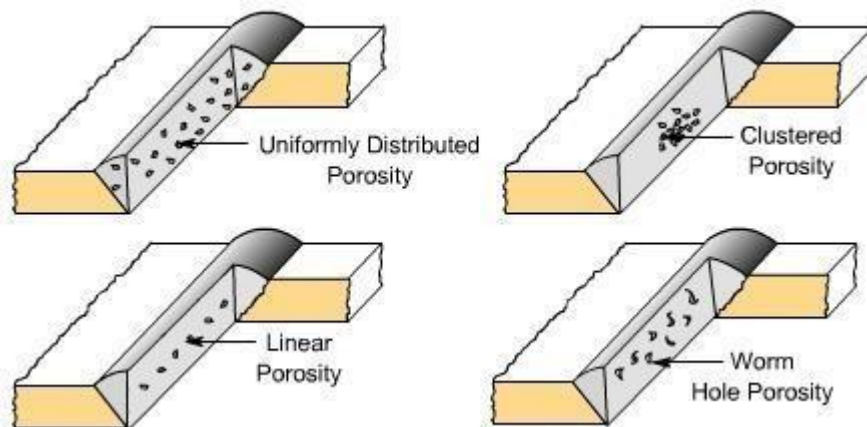

**Fig 13.1: Various Types of Cracks in Welds**

Cracks may be developed due to poor ductility of base metal, high sulphur and carbon contents, high arc travel speeds i.e. fast cooling rates, too concave or convex weld bead and high hydrogen contents in the weld metal.

### 2. Porosity

Porosity results when the gases are entrapped in the solidifying weld metal. These gases are generated from the flux or coating constituents of the electrode or shielding gases used during welding or from absorbed moisture in the coating. Rust, dust, oil and grease present on the surface of work pieces or on electrodes are also source of gases during welding. Porosity may be easily prevented if work pieces are properly cleaned from rust, dust, oil and grease. Further, porosity can also be controlled if excessively high welding currents, faster welding speeds and long arc lengths are avoided flux and coated electrodes are properly baked.



**Fig 13.2: Different Forms of Porosities**



### 3. Solid Inclusion

Solid inclusions may be in the form of slag or any other nonmetallic material entrapped in the weld metal as these may not be able to float on the surface of the solidifying weld metal. During arc welding flux either in the form of granules or coating after melting, reacts with the molten weld metal removing oxides and other impurities in the form of slag and it floats on the surface of weld metal due to its low density. However, if the molten weld metal has high viscosity or too low temperature or cools rapidly then the slag may not be released from the weld pool and may cause inclusion.

Slag inclusion can be prevented if proper groove is selected, all the slag from the previously deposited bead is removed, too high or too low welding currents and long arcs are avoided.

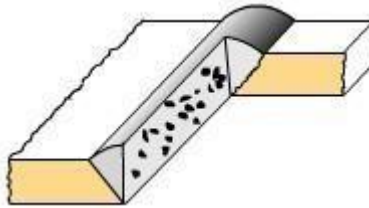

**Fig 13.3: Slag Inclusion in Weldments**

### 4. Lack of Fusion and Inadequate or incomplete penetration:

Lack of fusion is the failure to fuse together either the base metal and weld metal or subsequent beads in multipass welding because of failure to raise the temperature of base metal or previously deposited weld layer to melting point during welding. Lack of fusion can be avoided by properly cleaning of surfaces to be welded, selecting proper current, proper welding technique and correct size of electrode.

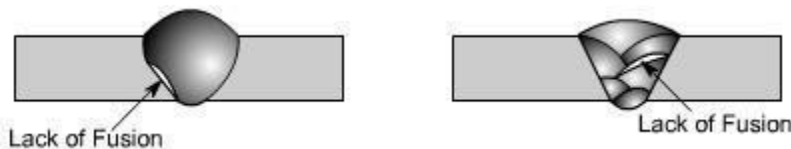

**Fig 13.4: Types of Lack of Fusion**

Incomplete penetration means that the weld depth is not upto the desired level or root faces have not reached to melting point in a groove joint. If either low currents or larger arc lengths or large root face or small root gap or too narrow groove angles are used then it results into poor penetration.

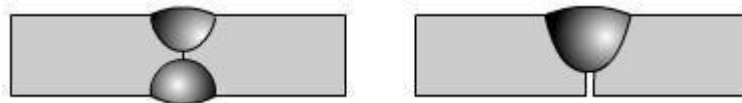

**Fig 13.5: Examples of Inadequate Penetration**

### 5. Imperfect Shape

Imperfect shape means the variation from the desired shape and size of the weld bead.

During undercutting a notch is formed either on one side of the weld bead or both sides in which stresses tend to concentrate and it can result in the early failure of the joint. Main reasons for undercutting are the excessive welding currents, long arc lengths and fast travel speeds.

Underfilling may be due to low currents, fast travel speeds and small size of electrodes. Overlap may occur due to low currents, longer arc lengths and slower welding speeds.

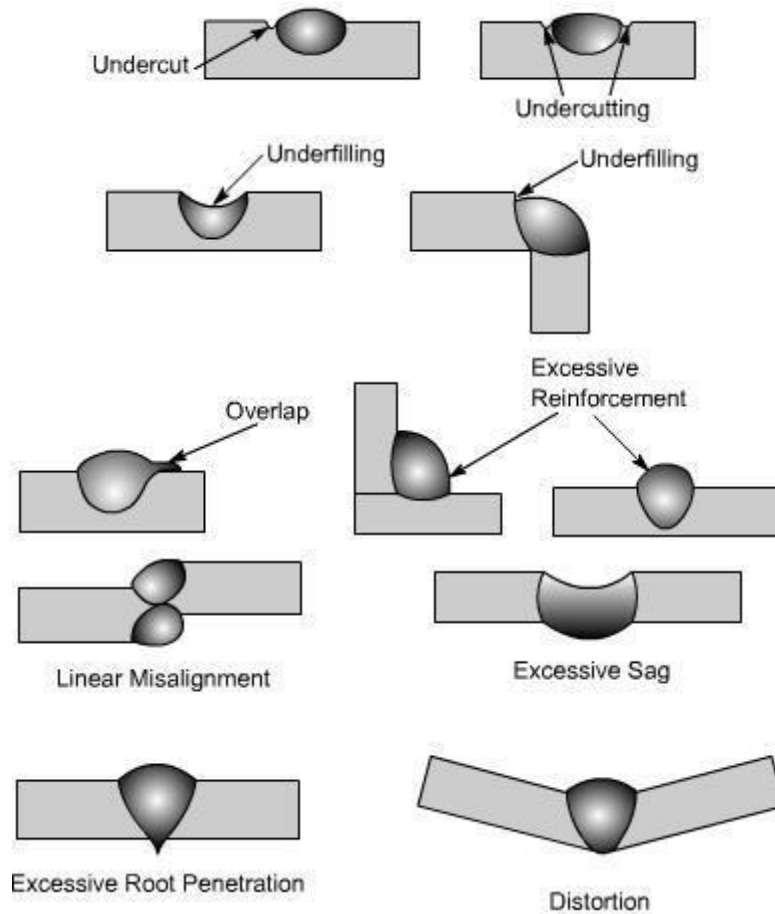

**Fig 13.6: Various Imperfect Shapes of Welds**

Excessive reinforcement is formed if high currents, low voltages, slow travel speeds and large size electrodes are used. Excessive root penetration and sag occur if excessive high currents and slow travel speeds are used for relatively thinner members.

Distortion is caused because of shrinkage occurring due to large heat input during welding.

### Miscellaneous Defects

Various miscellaneous defects may be multiple arc strikes i.e. several arc strikes are one behind the other, spatter, grinding and chipping marks, tack weld defects, oxidized surface in the region of weld, unremoved slag and misalignment of weld beads if welded from both sides in butt welds.

## UNIT – III

### Hot Working & Cold Working

#### Strengthening/Hardening Mechanisms

As discussed in the previous section, the ability of a crystalline material to plastically deform largely depends on the ability for dislocation to move within a material. Therefore, impeding the movement of dislocations will result in the strengthening of the material. There are a number of ways to impede dislocation movement, which include:

- controlling the grain size (reducing continuity of atomic planes)
- strain hardening (creating and tangling dislocations)
- alloying (introducing point defects and more grains to pin dislocation)

#### Control of Grain Size

The size of the grains within a material also has an effect on the strength of the material. The boundary between grains acts as a barrier to dislocation movement and the resulting slip because adjacent grains have different orientations. Since the atom alignment is different and slip planes are discontinuous between grains. The smaller the grains, the shorter the distance atoms can move along a particular slip plane. Therefore, smaller grains improve the strength of a material. The size and number of grains within a material is controlled by the rate of solidification from the liquid phase.

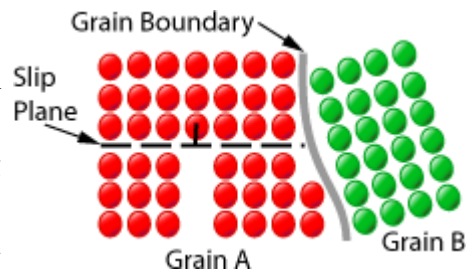

#### Strain Hardening

Strain hardening (also called work-hardening or cold-working) is the process of making a metal harder and stronger through plastic deformation. When a metal is plastically deformed, dislocations move and additional dislocations are generated. The more dislocations within a material, the more they will interact and become pinned or tangled. This will result in a decrease in the mobility of the dislocations and a strengthening of the material. This type of strengthening is commonly called cold-working. It is called cold-working because the plastic deformation must occur at a temperature low enough that atoms cannot rearrange themselves. When a metal is worked at higher temperatures (hot-working) the dislocations can rearrange and little strengthening is achieved.

Strain hardening can be easily demonstrated with piece of wire or a paper clip. Bend a straight section back and forth several times. Notice that it is more difficult to bend the metal at the same place. In the strain hardened area dislocations have formed and become tangled, increasing the strength of the material. Continued bending will eventually cause the wire to break at the bend due to fatigue cracking. (After a large number of bending cycles, dislocations form structures called Persistent Slip Bands (PSB). PSBs are basically tiny areas where the dislocations have piled up and moved the material surface out leave steps in the surface that act as stress risers or crack initiation points.)

It should be understood, however, that increasing the strength by cold-working will also result in a reduction in ductility. The graph to the right shows the yield strength and the percent elongation as a function of percent cold-work for a few example materials. Notice that for each material, a small amount of cold-working results in a significant reduction in ductility.

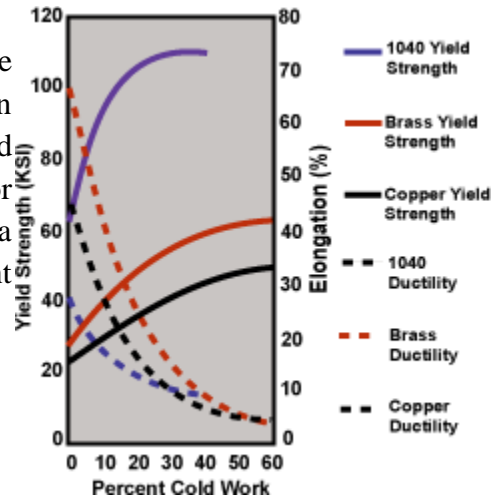

### Effects of Elevated Temperature on Strain Hardened Materials

When strain hardened materials are exposed to elevated temperatures, the strengthening that resulted from the plastic deformation can be lost. This can be a bad thing if the strengthening is needed to support a load. However, strengthening due to strain hardening is not always desirable, especially if the material is being heavily formed since ductility will be lowered.

Heat treatment can be used to remove the effects of strain hardening. Three things can occur during heat treatment:

1. Recovery
2. Recrystallization
3. Grain growth

#### Recovery

When a strain hardened material is held at an elevated temperature an increase in atomic diffusion occurs that relieves some of the internal strain energy. Remember that atoms are not fixed in position but can move around when they have enough energy to break their bonds. Diffusion increases rapidly with rising temperature and this allows atoms in severely strained regions to move to unstrained positions. In other words, atoms are freer to move around and recover a normal position in the lattice

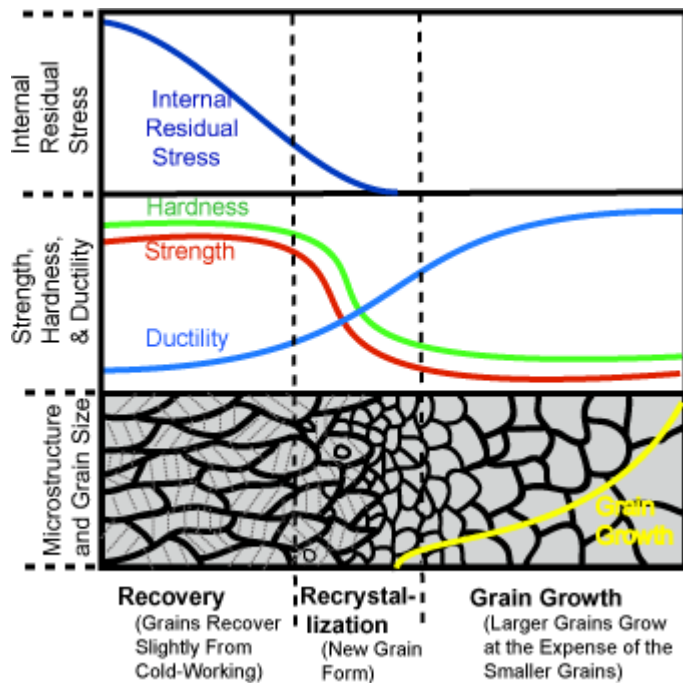

This is known as the recovery phase and it results in an adjustment of strain on a microscopic scale. Internal residual stresses are lowered due to a reduction in the dislocation density and a movement of dislocation to lower-energy positions. The tangles of dislocations condense into sharp two-dimensional boundaries and the dislocation density within these areas

decrease. These areas are called subgrains. There is no appreciable reduction in the strength and hardness of the material but corrosion resistance often improves.

### ***Recrystallization***

At a higher temperature, new, strain-free grains nucleate and grow inside the old distorted grains and at the grain boundaries. These new grains grow to replace the deformed grains produced by the strain hardening. With recrystallization, the mechanical properties return to their original weaker and more ductile states. Recrystallization depends on the temperature, the amount of time at this temperature and also the amount of strain hardening that the material experienced. The more strain hardening, the lower the temperature will be at which recrystallization occurs. Also, a minimum amount (typically 2-20%) of cold work is necessary for any amount of recrystallization to occur. The size the new grains is also partially dependant on the amount of strain hardening. The greater the stain hardening, the more nuclei for the new grains, and the resulting grain size will be smaller (at least initially).

### **Grain growth**

If a specimen is left at the high temperature beyond the time needed for complete recrystallization, the grains begin to grow in size. This occurs because diffusion occurs across the grain boundaries and larger grains have less grain boundary surface area per unit of volume. Therefore, the larger grains lose fewer atoms and grow at the expense of the smaller grains. Larger grains will reduce the strength and toughness of the material.

Comparison between hot working and cold working processes can be done in aspects like carried out temperature, stress set up, tolerances, hardening, deformation, surface finish, improved properties, cracks formation.

Introduction Rolling is one of the most important industrial metal forming operations. Hot Rolling is employed for breaking the ingots down into wrought products such as into blooms and billets, which are subsequently rolled to other products like plates, sheets etc.

Rolling is the plastic deformation of materials caused by compressive force applied through a set of rolls. The cross section of the work piece is reduced by the process. The material gets squeezed between a pair of rolls, as a result of which the thickness gets reduced and the length gets increased.

Mostly, rolling is done at high temperature, called hot rolling because of requirement of large deformations. Hot rolling results in residual stress-free product. However, scaling is a major problem, due to which dimensional accuracy is not maintained. Cold rolling of sheets, foils etc is gaining importance, due to high accuracy and lack of oxide scaling. Cold rolling also strengthens the product due to work hardening

Steel ingot is the cast metal with porosity and blowholes. The ingot is soaked at the hot rolling temperature of 1200o C and then rolled into blooms or billets or slabs.

Bloom is has a square cross section, with area more than 230 cm<sup>2</sup> . A slab, also from ingot, has rectangular cross-section, with area of at least 100 cm<sup>2</sup> and width at least three times the thickness. A billet is rolled out of bloom, has at least 40 mm X 40 mm cross-section.

Blooms are used for rolling structural products such as I-sections, channels, rails etc. Billets are rolled into bars, rods. Bars and rods are raw materials for extrusion, drawing, forging, machining etc. Slabs are meant for rolling sheets, strips, plates etc.

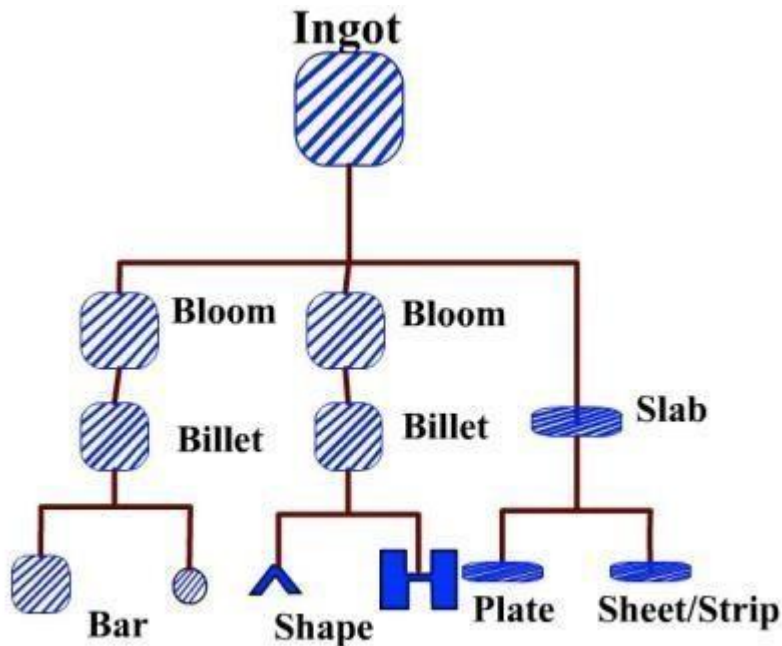

**Rolling sequence for fabrication of bars, shapes and flat products from blooms, billets and slabs**

Flow Chart shows rolling of different products

Plates have thickness greater than 6 mm whereas strips and sheets have less than 6 mm thickness. Sheets have greater width and strip has lower width – less than 600 mm.

### **Rolling mills:**

Rolling mill consists of rolls, bearings to support the rolls, gear box, motor, speed control devices, hydraulic systems etc. The basic type of rolling mill is two high rolling mill. In this mill, two opposing rolls are used. The direction of rotation of the rolls can be changed in case of reversing mills, so that the work can be fed into the rolls from either direction. Such mills increase the productivity. Non reversing mills have rolls rotating in same direction. Therefore, the work piece cannot be fed from the other side. Typical roll diameters may be 1.4 m.

A three high rolling mill has three rolls. First rolling in one direction takes place along one direction. Next the work is reversed in direction and fed through the next pair of roll. This improves the productivity.

Rolling power is directly proportional to roll diameter. Smaller dia rolls can therefore reduce power input. Strength of small diameter rolls are poor. Therefore, rolls may bend. As a result, larger diameter backup rolls are used for supporting the smaller rolls. Four high rolling mill is one such mill. Thin sections can be rolled using smaller diameter rolls. Cluster mill and Sendzimir mill are used for rolling thin strips of high strength materials and foils [0.0025 mm thick]. The work roll in these mills may be as small as 6 mm diameter – made of tungsten carbide. Several rolling mills arranged in succession so as to increase productivity is called rolling stand. In such arrangement, uncoiler and windup reels are used. They help in exerting back tension and front tension.

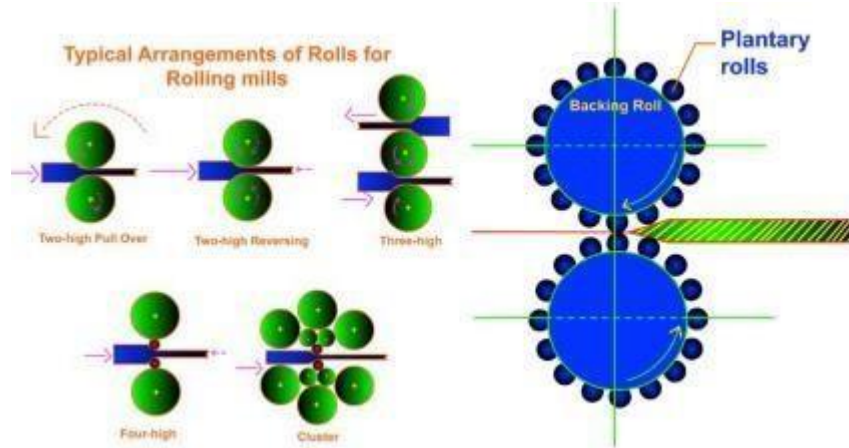

### Rolling Mills

Planetary mill has a pair of large heavy rolls, surrounded by a number of smaller rolls around their circumference. In this mill, a slab can be reduced to strip directly in one pass. Feeder rolls may be needed in order to feed the work piece into the rolls.

Merchant mill is specifically used for rolling bars.

Hot rolling is usually done with two high reversing mill in order to breakdown ingots into blooms and billets. For increased productivity, universal mill has two vertical rolls which can control the width of the work simultaneously.

Non ferrous materials are cold rolled into sheets from hot rolled strips. Four high tandem mills are generally used for aluminium and copper alloys. In order to achieve upto 90% reduction in thickness in cold rolling, a series of rolling mills may be used to share the total reduction.

One important application of cold rolling is the removal of yield point from mild steel sheets using skin pass rolling [temper rolling]. In this the steel sheet is given a light reduction of 0.5 to 1.5% . Such a process eliminates yield point elongation. If yield elongation of steel occurs during sheet metal operation, such as deep drawing, the surface of the sheet metal becomes rough due to formation of Luder bands, also called stretcher strains.

Flatness of rolled sheets can be increased by roller leveling. In this process, the sheet is passed between a pair of rolls which are driven by individual motors and are slightly offset.

Rolls should have high stiffness, hardness and strength. Cast iron, cast steel and forged steel are also used as rolls.

**Grain structure in rolling:** When the wrought or cast product gets hot rolled, the grain structure, which is coarse grained, becomes finer in size, but elongated along the

direction of



rolling. This type of textured grain structure results in directional property [anisotropy] for the rolled product. In order to refine the grains, heat treatment is performed immediately after rolling, which results in recrystallization after rolling.

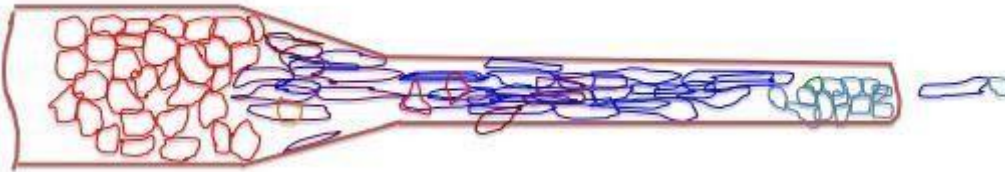

Variation of grain structure, size during longitudinal loading

**Special rolling processes:** Bulk deformation processes such as shape rolling, thread rolling, roll piercing, ring rolling also use pair of rolls. Some of such important processes are discussed briefly below:

**Thread and gear rolling:**

Threads on cylindrical work pieces can be cold formed using a pair of flat dies or cylindrical rolls under reciprocating or rotary motion. Screws, bolts and other externally threaded fasteners are produced by thread rolling. Thread rolling is a high productivity process involving no loss of material. Due to grain flow in thread rolling strength is increased. Surface finish of rolled threads is very good. Gears can also be produced by the thread rolling process. Compressive stresses introduced during the process is favourable for fatigue applications. Auto power transmission gears are made by thread rolling..

**Shape rolling:**

Structural sections such as I-sections, rails, channels can be rolled using set of shaped rolls. Blooms are usually taken as raw materials for shape rolling. Multiple steps are required in shape rolling.

**Ring rolling:**

Smaller diameter, thicker ring can be enlarged to larger diameter, thinner section by ring rolling. In this process, two circular rolls, one of which is idler roll and the other is driven roll are used. A pair of edging rollers are used for maintaining the height constant. The ring is rotated and the rings are moved closer to each other, thereby reducing the thickness of ring and increasing its diameter. Rings of different cross-sections can be produced. The major merits of this process are high productivity, material saving, dimensional accuracy and grain flow which is advantageous. Large rings for turbines, roller bearing races, flanges and rings for pipes are some of the applications of this process.

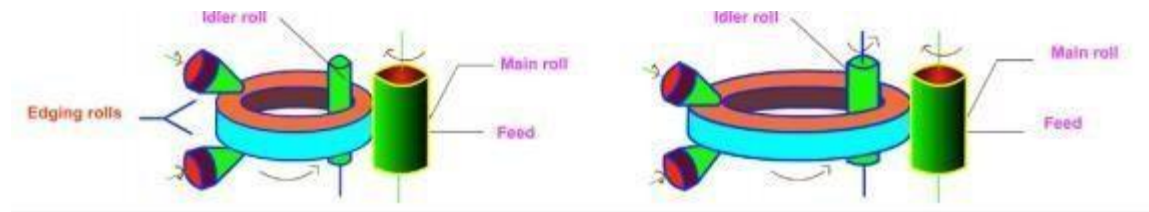

Ring Rolling Process

### Tube piercing:

Rotary tube piercing is used for producing long thick walled tubes. Cavity forms at the center due to tensile stress, in a round rod when subjected to external compressive stress – especially cyclic compressive stress.

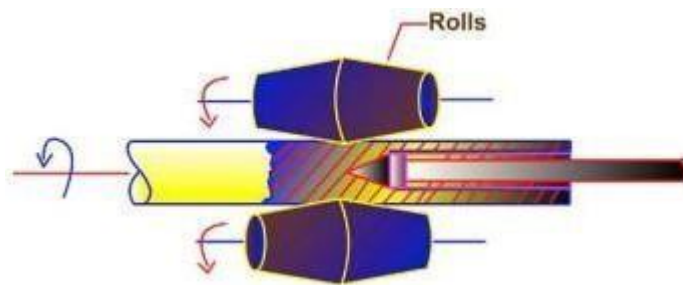

Mannesmann Mill

The Mannesmann process makes use of a tube piercing in rotary mode. A pair of skewed rolls are used for drawing the work piece inside the rolls. The roll axes are oriented at 6 degrees with reference to axis of work piece. A mandrel is used for expanding the central hole, and sizing the inner diameter. Pilger mill uses reciprocating motion of both work and mandrel to produce tubes. Work is periodically rotated additionally.

## POWER IN ROLLING

Power is applied to the rolling mill by applying Torque to the rolls and by using roll strip tension. The total rolling load is distributed over the arc of contact. However, the total rolling load can be assumed to be concentrated at point along the arc of contact at a distance 'a' from the line of centers of the rolls.

The ratio  $\lambda = [a/L_p] = [a/\sqrt{R \cdot \Delta t}]$  is used to calculate the moment arm 'a'

$\lambda = 0.5$  for hot rolling and  $0.45$  for cold rolling.

The torque is equal to the product of total rolling load and the effective moment arm.

Since there are two work rolls Torque  $M_t = 2P \cdot a$

Consider two high roll mill as shown in the figure. For one revolution of the top roll the resultant rolling load  $P$  moves along the circumference of a circle equal to  $2\pi \cdot a$

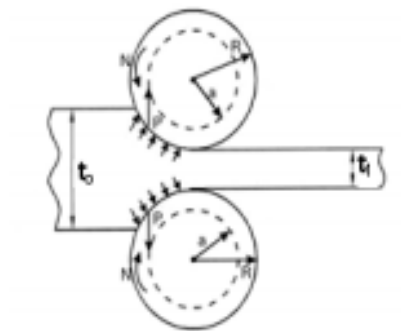

Since there are two work rolls involved, the work done is equal to  $\text{Work done} = 2(2\pi \cdot a) \cdot P = 4P \cdot \pi \cdot a$

If  $N$  is the speed of rotation of the rolls then

$$\text{Power} = \text{Work done/sec} = 4P \cdot \pi \cdot a \cdot N / 60$$

$$\text{I.e. Power} = (4P \cdot \pi \cdot a \cdot N / 60 \times 1000) \text{ Kw}$$

Where  $P$  = Load in Newton,  $a$  = moment arm in meters and

$N$  = speed rollers

This gives the power required for deformation of metal only.

### **Power Distribution:**

The power in rolling process is expended principally in four ways:

1. The energy required to deform the metal.
2. The energy required to overcome frictional force in bearings.
3. The energy lost in power transmission system.
4. The energy lost in the form of electrical losses in the motor etc.,

### **Torque and Power in Cold Rolling**

\*Power is applied to the rolling mill by applying Torque to the rolls and by using roll strip tension.\*The total rolling load is distributed over the arc of contact.

\*However, the total rolling load can be assumed to be concentrated at a point along the arc of contact at distance 'a' from the line of centers of the rolls.

### **Power Loss in Bearings**

**Due to friction in the bearings that support the rolls, there will be some power loss.**

**Since exact estimation of power loss in bearings is too complicated, approximate power loss estimation is done as shown.**

**Power loss in each bearing is given by:**

$$P_{\text{bearing}} = \frac{1}{2} \mu \cdot F_b \cdot d \cdot \omega$$

where  $\mu$  = Coefficient of friction in the bearings

(typical values lies in the range 0.002-0.01)

$F_b$  = Radial load for each bearing

= (1/2) x Roll separating force

= (1/2) x F (assuming rolls being supported on two bearings)

d = diameter of the bearing

$\omega$  = angular speed

**Structural shapes such as I, L, U, V ..etc., are produced by hot rolling process using grooved or contoured rolls.**

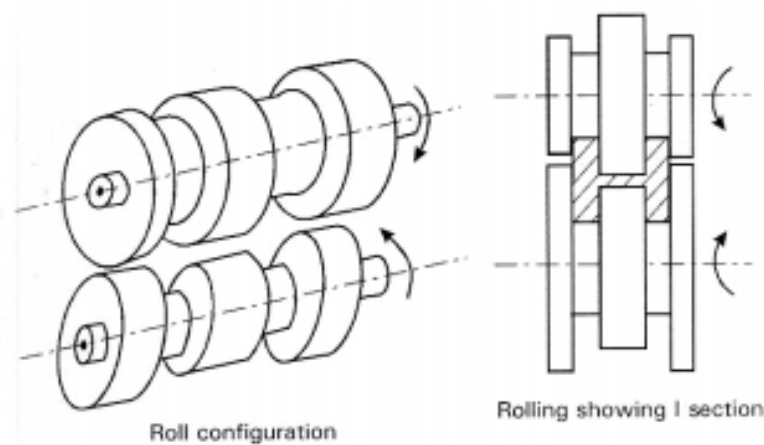

*Rolling of I section*

Usually 2 or 3 high mills are used for the purpose.

Reduction is carried out at several roll stands.

A tandem mill used for the purpose.

The design of roll pass is extremely complex and lot of experience is required for the purpose.

The contoured rolls will have half the shape of the section on each roll pairs. When assembled in the mill complete cross section is obtained. To control the lateral spread of the work it is turned through  $90^{\circ}$  after each pass before entering the next roll. The work passes through a series of such grooved rolls till the final size and shape is obtained. Grooves provide increased friction and large reduction in a short time is obtained effectively. The rolling of bars and other shapes is done in two directions i.e., the CS is reduced in two directions by rotating by  $90^{\circ}$  between each rolling. Whereas rolling of strip and sheet is carried out in one direction i.e., rolling is done without rotating the work piece.

**Blanking** is a process in which the punch operation removes a final product from a larger piece of sheet metal.

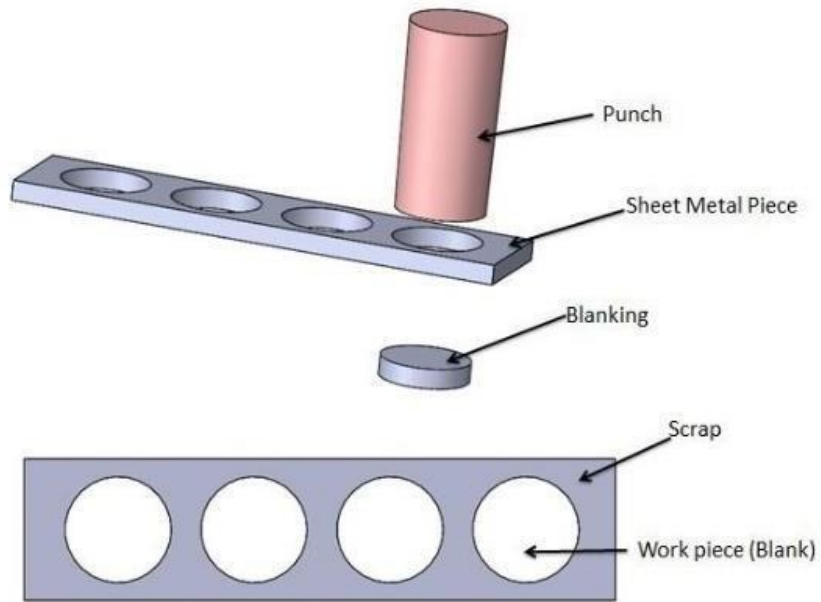

**Punching** is a material removal process in which the punch operation removes material from a final piece of sheet metal.

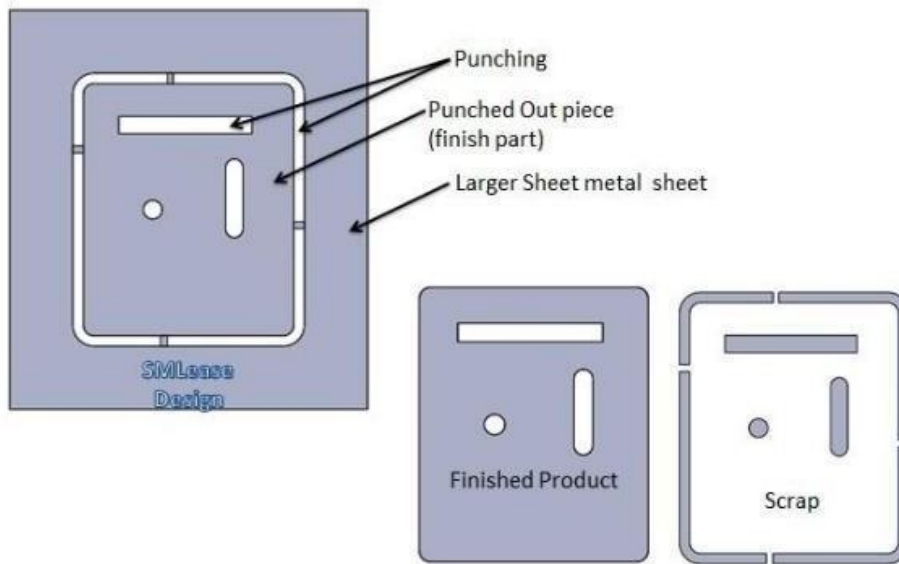

**Piercing** is process in which punch operation cuts a hole / material by tearing operation from a final piece of sheet metal. Piercing is a blanking operation

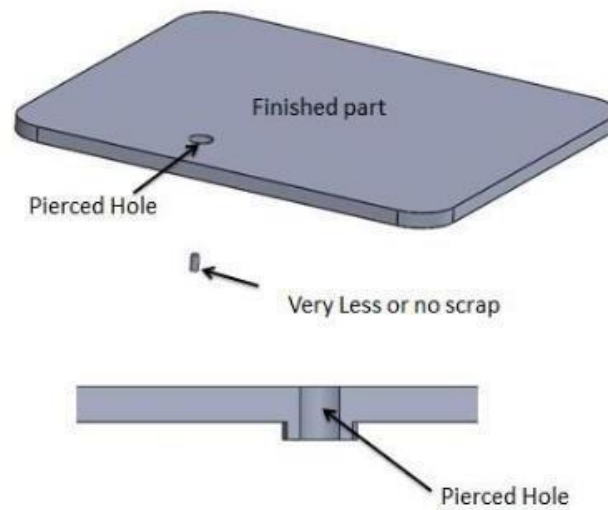

### **Metal Spinning:**

The metal spinning process starts with special machinery that produces rotationally symmetrical (i.e. cone-shaped) hollow parts; usually from circular blanks. Shear forming, a related process where parts are formed over a rotating conical mandrel, can be used to produce not only cone-shaped parts but also elliptical or other concave or convex parts. Often, shear forming is used in conjunction with metal spinning. Metal spinning is used as a replacement for the stamping and deep drawing processes.

The metal spinning process starts with a sheet metal blank which rotates on a lathe. The metal disc is pressed against a tool (called a mandrel or a chuck) with a tailstock. The metal disc, tailstock and tool rotate in a circular motion and a roller presses against the metal to form the metal over the tool through a series of passes by the roller. The resulting part is a piece that duplicates the exterior portion of the tool it was formed on. The basic shapes in metal spinning are cones, flanged covers, hemispheres, cylindrical shells, venturis and parabolic nose shapes.

Metal spinning yields pots and pans, vases, lamp shades, musical-instrument parts and trophies. Automotive parts include wheel discs, rims, hubcaps and clutch drums. Other examples include radar reflectors, parabolic dishes, hoppers, concrete-mixer bodies, drums, pressure bottles, tank ends, compensator and centrifuge parts, pulleys, hydraulic cylinders, engine inlet rings and a variety of jet-engine and missile parts.

Some of the advantages of metal spinning include -

1. Low capital-investment
2. Low tooling and energy costs



3. Short setup times
4. Quick and inexpensive adaptation of tooling and methods to accommodate design changes
5. Ability to carry out other operations such as beading, profiling, trimming and turning in the same production cycle with one setup.
6. Forming forces are appreciably lower than competing processes due to localized working.
7. Economical for one-off parts; prototypes; and small, medium and high volumes.
8. Any sheet material that can be cold formed is a candidate for metal spinning including - cold rolled steel, hot rolled steel, aluminum, stainless steel, brass, copper and exotic metals such as titanium, inconel, and hastelloy.

Tooling for spinning is relatively inexpensive and simple to employ, translating to a short lead time for parts. Tight tolerancing requirements may require secondary operations, but the advent of automated spinning machines allows more precise forming than with manual spinning machines, with less reliance on operator skill.

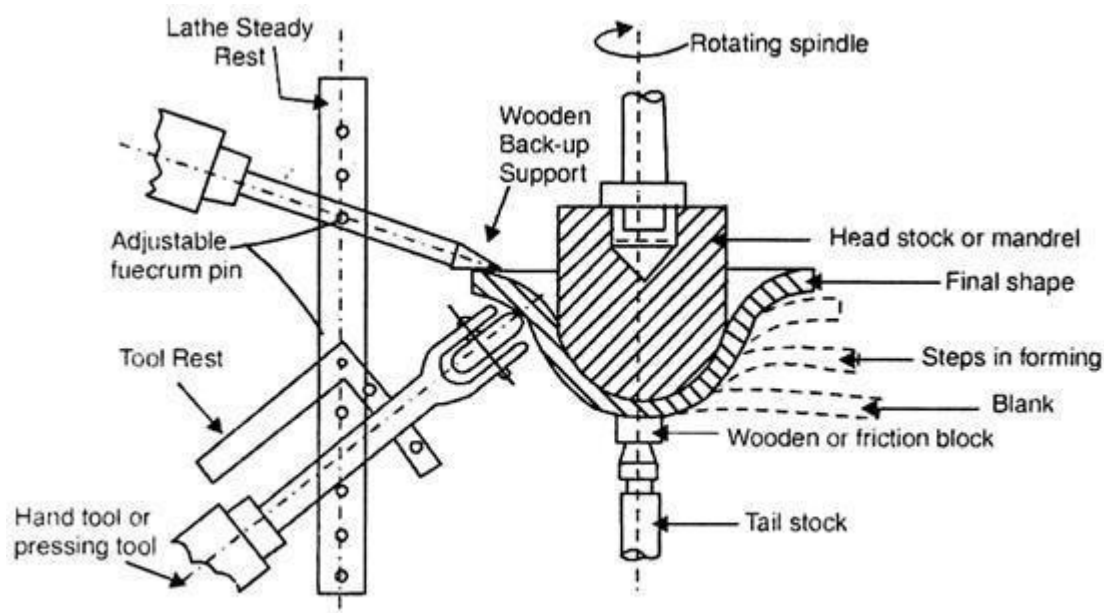

**Fig. 8.1.** A Schematic of the spinning operation.

The Spinning process is classified in two types i.e., hot-spinning and cold-spinning, depending upon whether the blank or work piece has been heated before spinning or not.

**(i) Hot Spinning:**

In hot spinning, the metal blank is heated to forging temperature and then forming it into the desired shape.

A blunt pressing tool is used which contacts the surface of the rotating part and causes the flow of metal over the form mandrel. This method is generally used for thicker plates and sheets, which do not plastically de-formed at room temperature by pressing tool.

In order to avoid wrinkling at the outer edge a back-up support (hard wood bar) opposite to the tool is used, when working with relatively thin sheets. Hot spinning produces parts such as heads for pressure vessels, refinery equipment's and large tanks.



### **(ii) Cold Spinning:**

Cold spinning process is similar to hot spinning except that the metal blank is worked at room temperature. This method is generally best suited for thin plates and sheets of aluminum and other soft metals.

Cold spinning produces parts such as light reflectors, cooking utensils, liquid containers, radial engine cowling, domestic use hollow parts etc.

### **Drawing:**

Drawing is a process of cold forming a flat precut metal blank into a hollow vessel without excessive wrinkling, thinning, or fracturing. The various forms produced may be cylindrical or box shaped, with straight or tapered sides or a combination of straight, tapered, and curved sides. The parts may vary from 1/4" (6mm) diam parts or smaller to aircraft or automotive parts large enough to require mechanical handling equipment.

Drawing is a process of cold forming a flat precut metal blank into a hollow vessel without excessive wrinkling, thinning, or fracturing. The various forms produced may be cylindrical or box shaped, with straight or tapered sides or a combination of straight, tapered, and curved sides. The parts may vary from 1/4" (6mm) diam parts or smaller to aircraft or automotive parts large enough to require mechanical handling equipment.

The **deep drawing process** is simply defined as the stretching of sheet metal stock, commonly referred to as a blank, around a plug. The edges of the metal blank are restrained by rings and the plug is deep drawn into a top die cavity to achieve the end shape that is desired. There are many shapes that can be made through deep drawing and stamping including --

1. cups
2. cans
3. pans
4. cylinders
5. domes
6. hemispheres
7. tubes
8. hoppers
9. Irregular shaped products.

## Unit - V

### Backgrounds

Conventional manufacturing processes such as machining, casting, assembly (fabrication), and metal forming finds applications in major automobile and aircraft industries. Among them metal forming as a technique has advantages over other manufacturing processes due its high precision in production of complex shapes with minimal material wastage and better mechanical properties. It has gained lot of importance in the past decade [1-2]. Metal forming is a process in which a metal block is being plastically deformed to a desired geometry. In order to obtain the deformation a force higher than the yield strength of the material is applied. Metal forming is a broad concept, can be classified into two major sections: bulk metal working processes and sheet metal working processes. Bulk metal deformation processes can be broadly of four types, namely, rolling, forging, extrusion and drawing. Forging and extrusion are frequently used forming processes since early 18<sup>th</sup> century [3]. Extrusion and forging having many advantages such as high dimensional accuracy, minimal or complete elimination of machining, good surface finish, better mechanical properties, quick production process and economic in comparison with other conventional manufacturing processes [4]. Extrusion and forging processes can be carried out under three working temperatures, namely, hot, cold and warm linked to recrystallization temperature. Cold forging and extrusion processes have more advantages compared to hot and warm processes with respect to geometrical accuracy, surface finish and mechanical properties of the final component [5].

### Different types of extrusion processes

Basically, cold extrusion is classified into four types depending on the relative movement of the punch and extruded product [6]. They are: forward (Direct) extrusion, backward (indirect) extrusion, radial (lateral) extrusion and impact extrusion [7].

#### Direct (Forward) extrusion

Forward extrusion process, represented in Figure 1.1, is the most common method used in the industries to manufacture long products of uniform cross-section. In this type of extrusion, the ram moves in the same direction of the extruded product. There is a relative movement between the

billet and container, leading to high frictional forces. Friction at the die and container wall increases the extrusion load requirements than that for indirect extrusion.

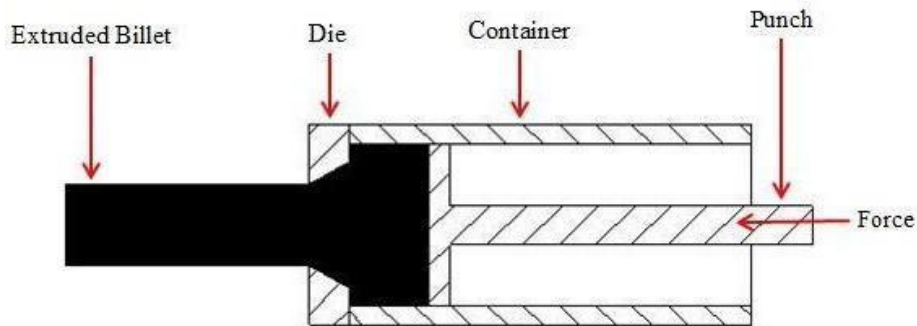

Figure 1.1: Direct extrusion

### **Indirect (Backward or Reverted) extrusion**

In this type of extrusion, the billet does not move relative to the container. A die fixed on a hollow ram which is pushed against the billet, leading to flow of the extruded section in opposite direction to the ram movement shown in Figure 1.2. Frictional force between billet and container interface is thus eliminated during indirect extrusion. Alternatively, the closed container end in backward extrusion can be forced to move against die and ram assembly.

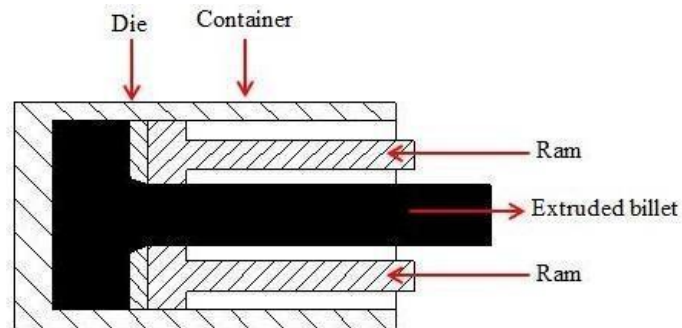

Figure 1.2: Indirect extrusion

### **Radial (Lateral) extrusion**

In this type of extrusion, the material flow perpendicularly to the direction of the punch movement as shown in Figure 1.3. Due to the change in metal flow direction additional power is required to overcome the friction at the die-billet interface. These types of extrusions are commonly used for production of flange type components.

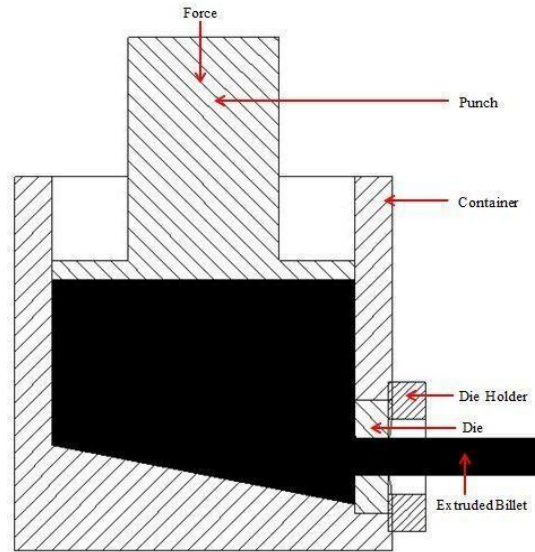

Figure 1.3: Radial extrusion

### Impact extrusion

This process (illustrated in Figure 1.4) is similar to backward/indirect extrusion process represented in Figure 1.2. The punch runs down quickly on the blank which gets revert extruded the punch to obtain a tubular section. The length of the tube depends on the size of the blank. Toothpaste tubes are an excellent example of this process.

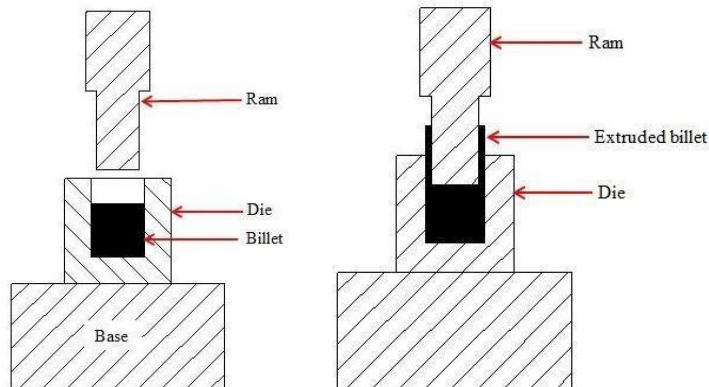

Figure 1.4: Impact extrusion

### Hydrostatic extrusion

Besides these four types of extrusion processes, we also have hydrostatic extrusion method in which the billet in the container is extruded through the die by the action of a hydrostatic liquid pressure medium rather than by direct application of the load with a ram represented in Figure 1.5.

The billet is surrounded by a hydrostatic fluid, which is sealed off and is pressurized sufficiently to extrude the billet through the die. This process can be done hot, warm, or cold, however; the temperature is limited by the stability of the fluid used. This method can be used to extrude brittle materials that cannot be processed by conventional extrusion since ductility of the material is improved by applying hydrostatic pressure.

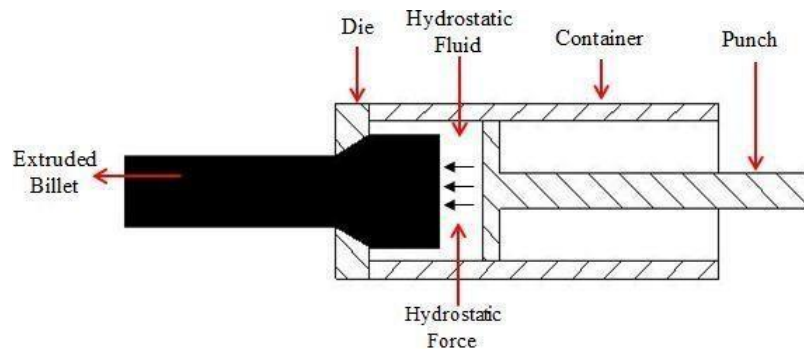

Figure 1.5: Hydrostatic extrusion

## Different types of forging processes

According to the nature of the applied force, forging is classified as:

**Hammer/drop forging:** The applied force is impact type.

**Press forging:** Load is applied gradually.

Based on the nature of material deformation or direction of applied force forging process is divided as:

### Upset forging

In this process, force is applied parallel to the length direction. This is the operation of increasing the cross section at the expense of length. Heads of nails, bolts and other hardware products are formed through this technique as shown in Figure 1.6.

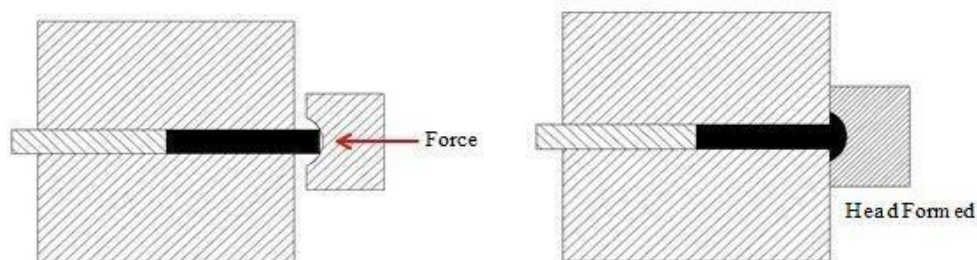

Figure 1.6: Upset forging

**Drawing out:** In this process, force is applied perpendicular to the length axis of the billet. This is the operation in which cross section area decreases with increase of length.

Based on the geometry of the dies by which material is compressed to get a shape forging process is divided as:

### Open die forging

In this type, the work is compressed between two flat dies, allowing metal to flow freely laterally with minimum constraint which is shown in Figure 1.7. These types of operations are performed for initial breakdown of the billet.

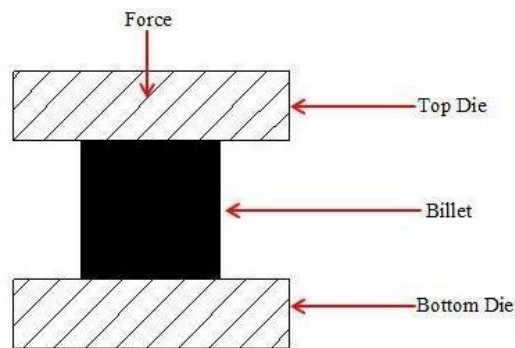

Figure 1.7: Open die forging

### Closed die or Impression die forging

In this type of process, the work piece is compressed between two die halves which carry the impressions of the desired shape that is to be imparted on the work piece shown in Figure 1.8. Metal flow is constrained and we get a multidirectional unbroken grain flow inside the product giving better mechanical properties. The extra metal is expelled out as flash mostly at parting line.

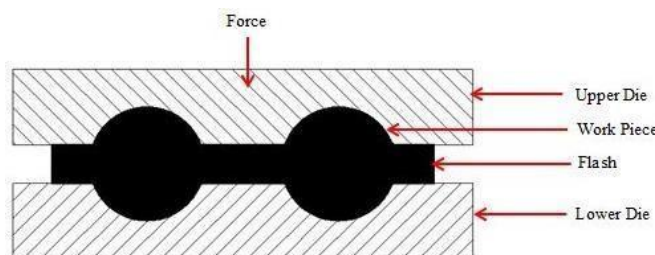

Figure 1.8: Closed die forging

### Flashless forging

In this type of forging the volume of the workpiece is equal to the volume of the die cavity, with no requirement of flash arrangement as shown in Figure 1.9.

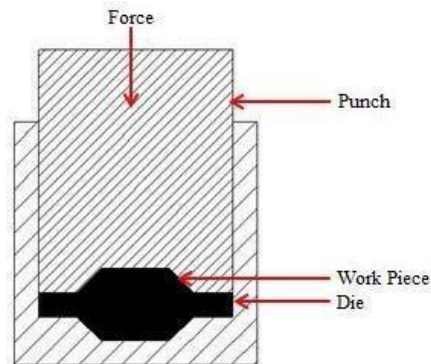

Figure 1.9: Flashless forging

### Combined extrusion forging processes

Because of industrial requirements various operation's, such as, direct and indirect extrusion and forging are combined to get complex shapes.

#### Combined forward and backward extrusion (CE)

In this combine process backward and forward extrusion takes place simultaneously as shown in the Figure 1.10.

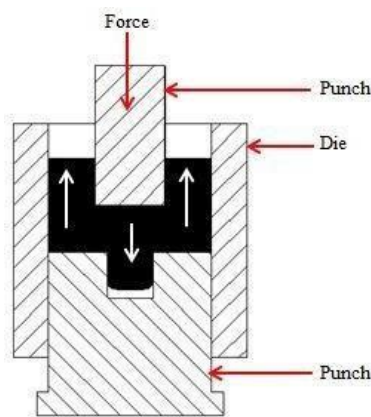

Figure 1.10: Forward-backward extrusion process

#### Combined extrusion-forging (CEF)

In this type of operation both extrusion and forging takes place simultaneously. As shown in Figure 1.11, forward extrusion takes place for forming of the shaft and forging takes place to form a flange. This process is also called cold heading with forging.

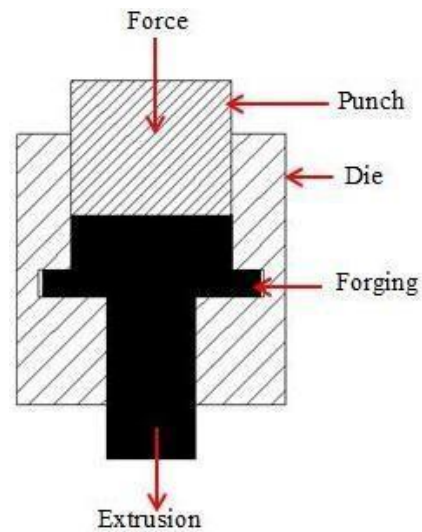

Figure 1.11: Extrusion-forging process

## Existing Manufacturing and Modern Industry Demand

The conventional metal extrusion and forging routes have gained importance involving single process (forward or backward extrusion, upsetting or closed die forging) for its manufacturing ability of components with better mechanical properties because of unbroken and multidirectional grain flow directions. The major hindrances encountered by the present manufacturing industries are to produce complex profiles with better surface finish, near net shape in one pass and improved mechanical properties. Due to the ever increasing demand of components with intricacy features single route is not sufficient to manufacture those parts, which lead to the significance of the combined extrusion-forging process.

In combined extrusion-forging technique, a billet is forced by a ram through the dies to flow in the same, opposite and perpendicular directions with respect to ram movement to obtain the desired shape. The beauty of this process is that two or more forming processes (different type of extrusion and forging) takes place simultaneously. Thereby, reducing the capital investment and we can obtain net or near-net shape product can be obtained by single ram movement at single station. Combined extrusion-forging (CEF) has drawn the attention of automobile, aircraft



industries and received industrial significance due to higher productivity, decrease in material wastage, better mechanical properties when compared to the existing conventional processes. Along with that, complex shapes can also be manufactured with ease, otherwise casting and machining are the present routes of manufacturing.

In the current market requirements, the use of complex aluminium sections are getting larger scope due to its properties of durability, wear resistance, low weight, etc. [8]. Combined extrusion–forging plays a very vital role for the production of near-net shaped products [9]. Metals like aluminium and aluminium based alloys play a predominant role in the cold CEF & CE processes. Due to the presence of high compressive stress, it minimizes cracks in the material in the initial breakdown of the ingot. Further, cold CEF is commercially preferred as it avoids complex tooling.

Although combined extrusion-forging has the ability to represent a better solution, analysis of this process has gained less importance till date due to its complexity nature.

## **Conventional Dies**

Dies are the replica of the profile which is to be extruded or forged. Those are used as mould/tooling device in manufacturing process for the extrusion, forging and combined extrusion-forging of profiles. The dies used should have higher mechanical characteristics, should be strong enough and have the ability to hold the dimensional accuracy during elevated stresses. In general, tool steels are used as metal extrusion/forging dies. High-grade alloy steels with coatings having higher wear resistance are also used for dies. For higher accuracy and wear resistance sometime carbides are also used as die materials. The essential technical requirements for fabrication of dies are:

- Die angle is an important factor for the material flow, which influences the force requirement. Although, accurate die angle is difficult to establish due to the influence of temperature and lubrication.
- The die design should consider the flash formation for the finishing operations, fillet, corner radii, and shrinkage.

## **Types of Dies**

In general, dies are of three types, namely, flat faced dies, conical dies and curved dies.

### Flat faced or square dies (Figure 1.12)

- These dies are most preferred in the industry due to its simple design and low cost.
- Flat faced dies are used to extrude simple designs of hard and tough metal.
- These dies form dead metal zones due to which the metal shears internally which form its own dies angle.
- Difficult for lubrication.

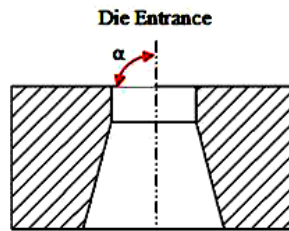

Figure 1.12: Square die

### Taper or conical dies (Figure 1.13)

- These dies have an entrance angle for metal flow.
- Dead metal zones are not present in these dies.
- Low frictional force is present when compared to the flat faced dies.
- Lubrication is easy.

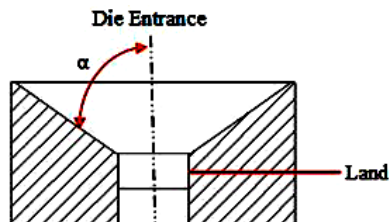

Figure 1.13: Taper die

### Curved dies (Figure 1.14)

- Friction loss and redundant work can be minimized
- It can be cosine, sine, elliptic, circular, hyperbolic, polynomial etc.

